

- Discount Code(s): 035 CPVC CTS Fittings \_\_\_\_\_  
 046 PVC Schedule 40 Molded Reinforced Fittings \_\_\_\_\_  
 076 CPVC Fire Spinkler Fittings w/Metal Inserts \_\_\_\_\_  
 085 CPVC & PVC Expansion Joints \_\_\_\_\_  
 086 PVC Schedule 80 Molded Reinforced Fittings \_\_\_\_\_  
 096 CPVC Schedule 80 Molded Reinforced Fittings \_\_\_\_\_  
 100 PVC Tank Adapters (Bulkhead Fittings) \_\_\_\_\_  
 101 CPVC Tank Adapters (Bulkhead Fittings) \_\_\_\_\_  
 895 Blue 75 Thread Sealant \_\_\_\_\_



*Item prices may have changed from those shown in this sheet. See Spears® On-line Catalog for most current pricing, updated daily.*

# Special Reinforced (SR) & Metal Thread Transition Fittings & Adapters



Quality Systems Certificate No. 293  
 Corporate Facilities, Sylmar, CA  
 Assessed to ISO 9001: 2008

Visit our web site:  
[www.spearsmfg.com](http://www.spearsmfg.com)

PRICE SCHEDULE TRAN-1-1009  
 Effective October 26, 2009  
 Supersedes TRAN-1-0308A



## Special Reinforced (SR) & Metal Thread Transition Fittings & Adapters

### TRANSITION FITTINGS OVERVIEW

Spears® Transition fittings are designed primarily for adapting plastic-to-metal systems. These fittings, especially the Special Reinforced (SR) Female Plastic Thread style, can also be used for superior strength in make-up of plastic threaded joints. Spears® offers a variety of transition adapter fittings specified below. All have standard ASTM socket sizes for IPS pipe and NPT threads, except for the Gasket Sealed style that uses a straight thread with elastomer seal. All other threads should be assembled with a quality grade thread sealant that is compatible with plastics.

**Warning:** Some pipe joint compounds or Teflon® pastes may contain substances that could cause stress cracking in thermoplastic materials. Spears® recommends the use of Spears® **BLUE 75™** thread sealant that has been tested for compatibility with Spears® products. Choice of any other appropriate thread sealant is at the discretion of the installer.

**Special Reinforced (SR) Thread Fittings:** This patented fitting features all-plastic female thread construction that reduces problems associated with over-tightening of female plastic pipe threads. The external reinforcing collar is not just an added reinforcement ring, this unique precompression design compensates for expansion forces generated from tapered pipe thread joint make-up. Radial stress is reduced in normal installations and contained in severe over-tightening situations. The all-plastic internal construction provides for the maximum in chemical and corrosion benefits. Its solid construction and reliability make the SR our best transition design for all applications.

**Brass Thread Fitting:** This patented fitting features a molded-in-place brass thread with external reinforcing collar as an integral part of each fitting for superior strength. An internal form-compressed O-ring seal compensates for expansion and contraction variations between materials. Excellent as a metal-to-plastic transition adapter fitting.

**Male Brass Thread Fitting:** Developed for Copper Tube Size (CTS) hot-and-cold water distribution systems, this male brass thread alternative is the only metal thread design of its type that has the metal component lined with plastic for improved fitting construction and minimal exposure. Excellent for transition to female metal threads in a CTS system.

**Gasket Sealed Thread Fittings:** Also developed for Copper Tube Size (CTS) hot-and-cold water distribution systems, this female threaded fitting features all plastic internal construction for maximum corrosion resistance. The fitting incorporates straight-threads for mechanical connection, while sealing is accomplished through an internal elastomer gasket or O-ring against the pipe face. No sealants are used.

### APPROVALS

Spears® Transition Fittings/Materials are approved for use in potable water systems by NSF International under ANSI/NSF Standard 61, Drinking Water System Components - Health Effects.

CPVC Orange Fittings in this price schedule (4200 series part numbers) are approved by Underwriters Laboratories, FM Global, and LPCB for use in CPVC Fire Sprinkler Systems. When installed in these system, installation must be made in accordance with Spears® publication FG-3, *FlameGuard™ CPVC Fire Sprinkler Products Installation Manual*, and local codes. However, these fittings can also be used in many other types of installations. CPVC fittings may also be used on PVC pipe when installed using a quality CPVC solvent cement meeting the requirements of ASTM F 493, Standard Specification for Solvent Cements for Chlorinated Poly (Vinyl Chloride) (CPVC) Plastic Pipe and Fittings.

NOT FOR USE WITH COMPRESSED AIR OR GAS

Spears® Manufacturing Company

# Special Reinforced (SR) & Metal Thread Transition Fittings & Adapters



## HOW TO USE THIS CATALOG

Spears® *Transition Fittings & Adapters* provides a concise listing of products specially designed for making plastic-to-metal system transitions. These include Spears® patented designs for Special Reinforced (SR) Female Plastic Thread Fittings and plastic fittings with molded-in Brass Threads. Selection can be made according to fitting material and type/color and then by part number with size, packaging and pricing information. Additional fitting types and configurations can be found in Spears® standard catalogs for each fitting material.

## ORGANIZATION

Products in this catalog are listed first by material type and color, then according to fitting transition-type and fitting configuration. Similar configurations such as Tees, Elbows, Adapters, etc., are grouped together according to size.

## PAGE & COLUMN HEADER INFORMATION

Each page header identifies the material, color and fitting transition-type. For example:

### PVC White Special Reinforced (SR) Fittings

Each product column header label identifies the following product particulars:

Part Number	the number used to order the part.
Size	nominal diameter of pipe with which the fitting is to be used. NOTE: Fittings may be same size (only one size designation) or reducing (multiple sizes designated).
Standard Pack (Std Pk)	the quantity of parts packaged in an individual box or bag.
Master Carton (Mstr Ctn)	the total quantity of parts contained in individual boxes or bags which are packaged together.
Discount Code (Disc Code)	identification code for applicable discount to the list price of the product. NOTE: This is a Product Group code and is not a calculation of discount. Discount codes are not the same for all products contained in this price schedule.
Price Each	the designated list price of the product.

## PRODUCT CONFIGURATION

Each group of product configuration types is headed by the product's name. An abbreviated configuration description of the fitting outlet connection is listed below the column headers. Line drawing illustrations are general representations of the fittings in the group, but may not be an exact depiction of all configurations listed. Line drawings are correlated to the configuration description. The drawing is read left to right for Elbow and Adapter configurations; bushings are read as outside x inside configuration. Tees have an additional outlet branch and are read left to right (run) then top (branch). The configuration description also correlates to the size designation. As with the nominal size designations, only one description is given when all outlets are the same. Reducing sizes list run configuration x branch configuration. Refer to illustration below:

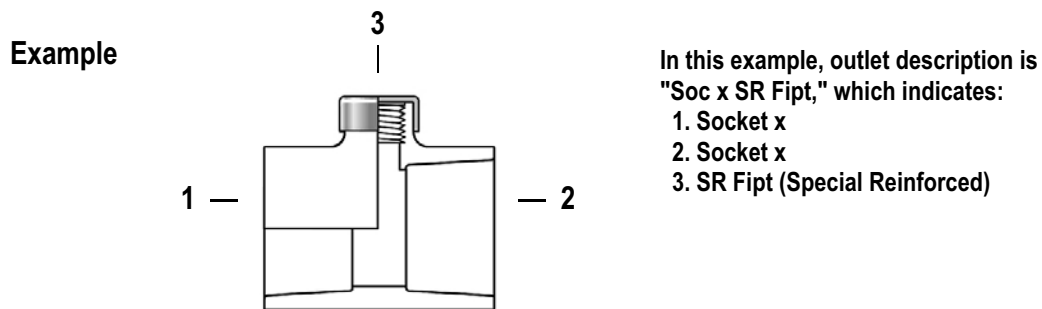

Product Name ————— **Special Reinforced Reducing Tee**

Abbreviated Configuration Description ————— **Soc x SR Fipt - Stainless Steel Collar**

Part Number	Size	Std Pk	Mstr Ctn	Disc Code	Price Each
402-072SR	1/2X1/4	25	150	046	6.77
402-098SR	3/4X1/4	25	100	046	8.79
402-101SR	3/4X1/2	50	0	046	8.79

NOT FOR USE WITH COMPRESSED AIR OR GAS



# PVC White Special Reinforced (SR) Fittings

Part Number	Size	Std Pk	Mstr Ctn	Disc Code	Price Each
-------------	------	--------	----------	-----------	------------

### Special Reinforced Female Adapter Soc x SR Fipt - Stainless Steel Collar

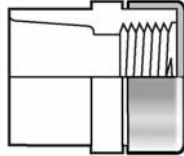

435-002SR	1/4	25	450	046	4.99
435-003SR	3/8	25	300	046	4.99
435-005SR	1/2	25	300	046	2.77
435-007SR	3/4	25	300	046	4.03
435-010SR	1	25	200	046	6.00
435-012SR	1-1/4	10	60	046	9.70
435-015SR	1-1/2	10	80	046	11.94
435-020SR	2	10	0	046	20.82
435-025SR	2-1/2	5	0	046	32.85
435-030SR	3	10	0	046	37.02
435-040SR	4	5	0	046	63.62

### Special Reinforced Tee Soc x SR Fipt - Stainless Steel Collar

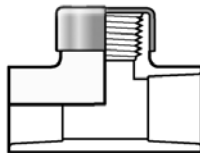

402-005SR	1/2	25	200	046	7.20
402-012SR	1-1/4	25	0	046	14.16

### Special Reinforced Reducing Tee Soc x SR Fipt - Stainless Steel Collar

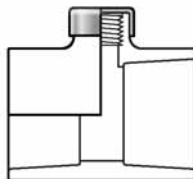

402-072SR	1/2X1/4	25	150	046	7.20
402-098SR	3/4X1/4	25	100	046	9.35
402-101SR	3/4X1/2	50	0	046	9.35
402-166SR	1-1/4X1/2	15	0	046	15.64
402-168SR	1-1/4X1	10	0	046	15.96
402-212SR	1-1/2X1-1/4	10	0	046	17.28
402-287SR	2-1/2X1/2	10	0	046	21.03
402-288SR	2-1/2X3/4	10	0	046	22.22
402-289SR	2-1/2X1	10	0	046	22.44
402-290SR	2-1/2X1-1/4	10	0	046	22.09
402-291SR	2-1/2X1-1/2	10	0	046	22.96
402-292SR	2-1/2X2	10	0	046	23.15
402-333SR	3X1/2	10	0	046	28.04
402-334SR	3X3/4	10	0	046	28.04
402-335SR	3X1	10	0	046	28.60
402-336SR	3X1-1/4	10	0	046	29.27
402-337SR	3X1-1/2	10	0	040	29.02

Part Number	Size	Std Pk	Mstr Ctn	Disc Code	Price Each
-------------	------	--------	----------	-----------	------------

### Special Reinforced Reducing Tee Soc x SR Fipt - Stainless Steel Collar (continued)

402-338SR	3X2	6	0	046	30.74
402-417SR	4X1	6	0	046	37.14
402-419SR	4X1-1/2	10	0	046	40.80
402-420SR	4X2	10	0	046	42.12
402-422SR	4X3	6	0	046	66.18

### Special Reinforced Reducing Tee Soc x SR Fipt-Stainless Steel Collar x Soc

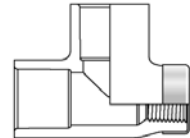

403-095SR	3/4X1/2X3/4	50	0	046	2.43
-----------	-------------	----	---	-----	------

### Special Reinforced 90° Ell & Reducing 90° Ell Soc x SR Fipt - Stainless Steel Collar

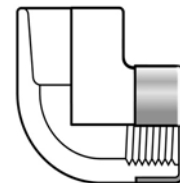

407-005SR	1/2	50	400	046	6.38
407-007SR	3/4	75	0	046	8.20
407-010SR	1	50	0	046	8.29
407-131SR	1X3/4	50	0	046	3.52
407-168SR <sup>1</sup>	1-1/4X1	25	0	046	13.88
407-249SR	2X1	10	0	046	15.79
407-251SR	2X1-1/2	10	0	046	16.66

Sized with SR Adapter

### Special Reinforced Coupling SR Fipt - Stainless Steel Collar

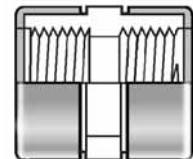

430-005SR	1/2	25	300	046	3.30
430-007SR	3/4	25	300	046	4.69
430-010SR	1	25	200	046	5.01
430-012SR	1-1/4	10	120	046	6.24
430-015SR	1-1/2	10	60	046	13.82
430-020SR	2	10	0	046	14.49

NOT FOR USE WITH COMPRESSED AIR OR GAS

# PVC White Special Reinforced (SR) Fittings



Part Number	Size	Std Pk	Mstr Ctn	Disc Code	Price Each
-------------	------	--------	----------	-----------	------------

## Special Reinforced Reducer Coupling SR Fipt - Stainless Steel Collar

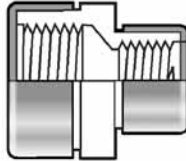

430-101SR	3/4X1/2	50	200	046	7.11
-----------	---------	----	-----	-----	------

## Special Reinforced Spigot Female Adapter Spig x SR Fipt - Stainless Steel Collar

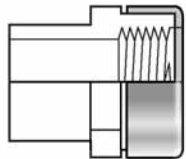

478-005SR	1/2	50	600	046	3.65
478-007SR	3/4	25	300	046	4.30
478-010SR	1	50	0	046	6.62
478-012SR	1-1/4	25	0	046	10.54
478-015SR	1-1/2	25	0	046	12.63
478-020SR	2	15	0	046	21.03
478-030SR	3	5	0	046	38.65
478-040SR	4	5	0	046	65.62

## Special Reinforced Reducing Spigot Female Adapter Spig x SR Fipt - Stainless Steel Collar

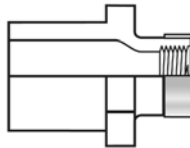

478-072SR	1/2X1/4	25	450	046	10.13
478-098SR	3/4X1/4	50	300	046	14.76
478-128SR	1X1/4	50	400	046	15.22

Spears® SR Series reinforced spigot adapters can be user-installed in a variety of socket type tees, elbows and reducer bushings for superior thread reinforcement demanding applications.

## Special Reinforced Reducing Female Adapter Soc x SR Fipt - Stainless Steel Collar

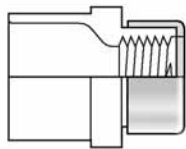

435-072SR	1/2x1/4	50	600	046	3.63
435-074SR	1/2X3/4	50	400	046	4.03
435-101SR	3/4X1/2	50	400	046	4.03
435-102SR	3/4X1	50	0	046	6.00
435-130SR	1X1/2	50	0	046	6.00
435-131SR	1X3/4	25	200	046	6.00

Part Number	Size	Std Pk	Mstr Ctn	Disc Code	Price Each
-------------	------	--------	----------	-----------	------------

## Special Reinforced Reducer Bushing Flush Style Spig x SR Fipt - Stainless Steel Collar

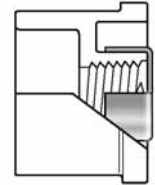

438-128SR	1X-1/4	25	300	046	2.95
438-166SR	1-1/4X1/2	25	100	046	5.40
438-207SR	1-1/2X1/4	25	100	046	7.53
438-209SR	1-1/2X1/2	25	100	046	7.53
438-210SR	1-1/2X3/4	25	100	046	7.53
438-247SR	2X1/2	10	80	046	9.21
438-248SR	2X3/4	10	80	046	9.21
438-249SR	2X1	10	80	046	9.21
438-334SR	3X3/4	10	0	046	36.06
438-335SR	3X1	10	0	046	36.06
438-336SR	3X-1/4	10	0	046	36.06
438-337SR	3X1-1/2	10	0	046	36.06
438-420SR	4X2	6	0	046	55.43
438-421SR	4X2-1/2	6	0	046	62.39
438-528SR	6X2	5	0	046	63.84
438-530SR	6X3	5	0	046	57.46
438-532SR	6X4	5	0	046	63.84

## Special Reinforced Reducer Bushing Flush Style Mipt x SR Fipt - Stainless Steel Collar

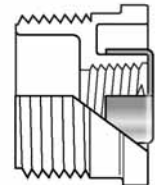

439-209SR	1-1/2X1/2	25	200	046	7.80
439-249SR	2X1	10	120	046	11.46

## Special Reinforced Cap SR Fipt - Stainless Steel Collar

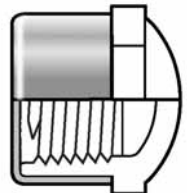

448-012SR	1-1/4	25	100	046	6.02
-----------	-------	----	-----	-----	------

NOT FOR USE WITH COMPRESSED AIR OR GAS

Made in the U.S.A.

Progressive Products from Spears® Innovation and Technology

Page 4



# PVC White Special Reinforced (SR) Fittings

Part Number	Size	Std Pk	Mstr Ctn	Disc Code	Price Each
-------------	------	--------	----------	-----------	------------

**Special Reinforced Union  
Soc x SR Fipt with Buna O-ring Seal -  
Stainless Steel Collar**

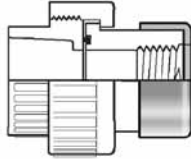

459-002SR	1/4	25	150	046	13.68
459-003SR	3/8	25	100	046	13.68
459-005SR	1/2	10	60	046	7.43
459-007SR	3/4	10	40	046	10.23
459-010SR	1	10	0	046	13.61
459-012SR	1-1/4	5	20	046	25.98
459-015SR	1-1/2	5	0	046	32.16
459-020SR	2	5	0	046	49.53
459-030SR	3	5	0	046	116.94
459-040SR	4	4	0	046	134.26
459-060SR	6	1	0	046	298.36

**Special Reinforced Union  
Soc x SR Fipt with EPDM O-ring Seal -  
Stainless Steel Collar**

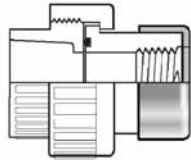

499-002SR	1/4	25	150	046	15.02
499-003SR	3/8	25	100	046	15.02
499-005SR	1/2	10	60	046	8.16
499-007SR	3/4	10	40	046	11.24
499-010SR	1	10	40	046	14.94
499-012SR	1-1/4	5	20	046	28.55
499-015SR	1-1/2	5	0	046	35.34
499-020SR	2	5	0	046	54.43
499-030SR	3	5	0	046	128.51
499-040SR	4	4	0	046	147.53
499-060SR	6	1	0	046	327.87

NOT FOR USE WITH COMPRESSED AIR OR GAS

# PVC White Brass Thread Fittings



Part Number	Size	Std Pk	Mstr Ctn	Disc Code	Price Each
-------------	------	--------	----------	-----------	------------

**Transition Union  
Soc x Fipt with Brass Thread Insert &  
Buna-N O-ring Seal**

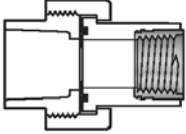

459-010BR	1	10	0	046	57.81
459-012BR	1-1/4	5	20	046	97.12
459-015BR	1-1/2	5	0	046	128.50
459-020BR	2	5	0	046	171.40

Not intended to convey or dispense water for human consumption through drinking or cooking

**Transition Union  
Soc x Fipt with Brass Thread Insert &  
EPDM O-ring Seal**

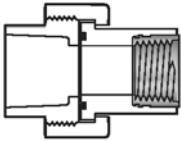

499-010BR	1	10	0	046	57.81
499-012BR	1-1/4	5	20	046	97.12
499-015BR	1-1/2	5	0	046	128.50
499-020BR	2	5	0	046	171.40

Not intended to convey or dispense water for human consumption through drinking or cooking

NOT FOR USE WITH COMPRESSED AIR OR GAS

Made in the U.S.A.

**Progressive Products from Spears® Innovation and Technology**



# PVC Gray Special Reinforced (SR) Fittings

Part Number	Size	Std Pk	Mstr Ctn	Disc Code	Price Each
-------------	------	--------	----------	-----------	------------

### Special Reinforced Tee Soc x SR Fipt - Stainless Steel Collar

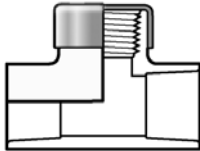

802-005SR	1/2	25	200	086	7.20
802-007SR	3/4	15	120	086	10.18
802-010SR	1	15	0	086	11.96
802-012SR	1-1/4	25	0	086	14.22
802-015SR	1-1/2	10	0	086	15.03
802-030SR	3	5	0	086	63.54
802-040SR	4	5	0	086	119.17

### Special Reinforced Tee SR Fipt - Stainless Steel Collar

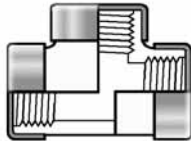

805-002SR	1/4	25	150	086	8.38
805-003SR	3/8	25	150	086	8.38
805-005SR	1/2	25	150	086	8.65
805-007SR	3/4	25	100	086	9.50
805-010SR	1	15	0	086	22.59
805-015SR	1-1/2	10	0	086	26.43
805-020SR	2	10	0	086	27.79

### Special Reinforced Reducing Tee Soc x SR Fipt - Stainless Steel Collar

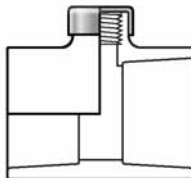

802-072SR	1/2X1/4	25	150	086	7.20
802-098SR	3/4X1/4	25	100	086	9.35
802-101SR	3/4X1/2	50	0	086	9.35
802-128SR <sup>1</sup>	1X1/4	10	80	086	22.14
802-130SR	1X1/2	50	0	086	11.53
802-131SR	1X3/4	15	0	086	22.14
802-164SR <sup>1</sup>	1-1/4X1/4	5	0	086	23.60
802-166SR	1-1/4X1/2	15	0	086	15.64
802-168SR	1-1/4X1	10	0	086	15.96
802-207SR <sup>1</sup>	1-1/2X1/4	10	0	086	27.54
802-211SR	1-1/2X1	10	0	086	17.28
802-212SR	1-1/2X1-1/4	10	0	086	17.28
802-245SR <sup>1</sup>	2X1/4	10	0	086	31.81
802-247SR	2X1/2	10	0	086	31.81
802-248SR	2X3/4	10	0	086	31.81
802-287SR	2-1/2X1/2	10	0	086	23.44

Part Number	Size	Std Pk	Mstr Ctn	Disc Code	Price Each
-------------	------	--------	----------	-----------	------------

### Special Reinforced Reducing Tee Soc x SR Fipt - Stainless Steel Collar (continued)

802-331SR <sup>1</sup>	3X1/4	5	0	086	60.72
802-333SR <sup>1</sup>	3X1/2	5	0	086	62.48
802-413SR <sup>1</sup>	4X1/4	5	0	086	83.62
802-415SR <sup>1</sup>	4X1/2	5	0	086	90.88

<sup>1</sup> Sized with Bushing

### Special Reinforced Reducing Tee Soc x SR Fipt - Stainless Steel Collar x Soc

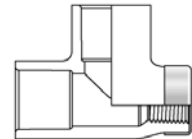

803-095SR	3/4X1/2X3/4	15	0	086	11.78
-----------	-------------	----	---	-----	-------

### Special Reinforced 90° Ell Soc x SR Fipt - Stainless Steel Collar

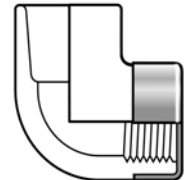

807-005SR	1/2	20	240	086	6.89
807-007SR	3/4	75	0	086	8.20
807-010SR	1	50	0	086	8.29
807-012SR	1-1/4	25	0	086	11.14
807-015SR	1-1/2	10	0	086	13.76
807-020SR	2	10	0	086	15.79
807-030SR	3	5	0	086	40.09
807-040SR	4	5	0	086	70.83

### Special Reinforced 90° Ell SR Fipt - Stainless Steel Collar

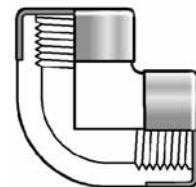

808-003SR	3/8	25	150	086	4.02
808-005SR	1/2	20	120	086	4.02
808-007SR	3/4	20	120	086	5.07
808-010SR	1	50	0	086	5.89
808-012SR	1-1/4	25	0	086	6.30
808-015SR	1-1/2	10	0	086	9.82

NOT FOR USE WITH COMPRESSED AIR OR GAS

# PVC Gray Special Reinforced (SR) Fittings



Part Number	Size	Std Pk	Mstr Ctn	Disc Code	Price Each
-------------	------	--------	----------	-----------	------------

**Special Reinforced 90° EII**  
**SR Fipt - Stainless Steel Collar (continued)**

808-020SR	2	10	0	086	11.06
-----------	---	----	---	-----	-------

**Special Reinforced Reducing 90° EII**  
**Soc x SR Fipt - Stainless Steel Collar**

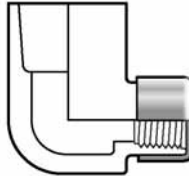

807-101SR	3/4X1/2	50	0	086	8.18
807-130SR	1X1/2	50	0	086	9.18

**Special Reinforced 45° EII**  
**SR Fipt - Stainless Steel Collar**

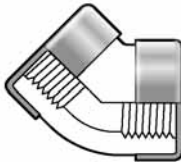

819-007SR	3/4	10	120	086	6.93
-----------	-----	----	-----	-----	------

**Special Reinforced Coupling**  
**SR Fipt - Stainless Steel Collar**

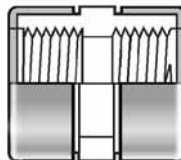

830-005SR	1/2	25	150	086	3.30
830-007SR	3/4	25	150	086	4.69
830-010SR	1	25	200	086	5.01
830-012SR	1-1/4	10	120	086	6.24
830-015SR	1-1/2	10	80	086	13.82
830-020SR	2	10	0	086	14.49

**Special Reinforced Reducer Coupling**  
**SR Fipt - Stainless Steel Collar**

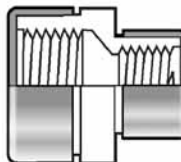

830-101SR	3/4X1/2	50	200	086	4.27
830-130SR	1X1/2	50	0	086	6.34
830-131SR	1X3/4	25	200	086	6.34
830-168SR	1-1/4X1	25	0	086	13.59

Part Number	Size	Std Pk	Mstr Ctn	Disc Code	Price Each
-------------	------	--------	----------	-----------	------------

**Special Reinforced Reducer Coupling**  
**SR Fipt - Stainless Steel Collar (continued)**

830-210SR	1-1/2X3/4	25	0	086	20.17
830-211SR	1-1/2X1	10	80	086	20.17
830-212SR	1-1/2X1-1/4	10	80	086	20.17
830-249SR	2X1	25	0	086	26.73
830-251SR	2X1-1/2	10	0	086	26.73

**Special Reinforced Female Adapter**  
**Soc x SR Fipt - Stainless Steel Collar**

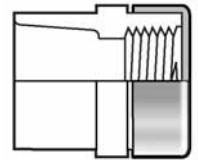

835-002SR	1/4	25	450	086	4.99
835-003SR	3/8	25	300	086	4.99
835-005SR	1/2	25	300	086	2.77
835-007SR	3/4	25	300	086	4.03
835-010SR	1	25	200	086	6.00
835-012SR	1-1/4	10	60	086	9.70
835-015SR	1-1/2	10	80	086	11.94
835-020SR	2	10	0	086	20.82
835-025SR	2-1/2	5	0	086	32.85
835-030SR	3	15	0	086	37.02
835-040SR	4	5	0	086	63.62
835-060SR	6	6	0	086	82.65

**Encapsulated Special Reinforced Female Adapter**  
**Soc x ESR Fipt**

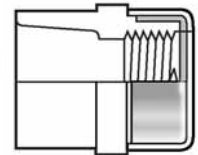

835-002ESR	1/4	25	450	086	7.23
835-003ESR	3/8	25	300	086	7.23
835-005ESR	1/2	25	300	086	4.48
835-007ESR	3/4	25	300	086	6.62
835-010ESR	1	25	200	086	8.76
835-012ESR	1-1/4	10	80	086	14.14
835-015ESR	1-1/2	10	80	086	20.43
835-020ESR	2	10	0	086	30.36

NOT FOR USE WITH COMPRESSED AIR OR GAS

Made in the U.S.A.

Progressive Products from Spears® Innovation and Technology



# PVC Gray Special Reinforced (SR) Fittings

Part Number	Size	Std Pk	Mstr Ctn	Disc Code	Price Each
-------------	------	--------	----------	-----------	------------

**Special Reinforced Spigot Female Adapter**  
Spig x SR Fipt - Stainless Steel Collar

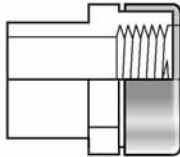

878-005SR	1/2	50	600	086	3.65
878-007SR	3/4	25	300	086	4.30
878-010SR	1	50	0	086	6.62
878-012SR	1-1/4	25	0	086	10.54
878-015SR	1-1/2	25	0	086	12.63
878-020SR	2	15	0	086	21.03
878-030SR	3	5	0	086	38.65
878-040SR	4	5	0	086	65.62

**Encapsulated Special Reinforced Spigot Female Adapter**  
Spig x ESR Fipt

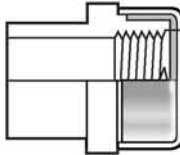

878-005ESR	1/2	50	600	086	4.97
878-007ESR	3/4	25	300	086	6.85
878-010ESR	1	50	0	086	9.40
878-012ESR	1-1/4	25	0	086	14.47
878-015ESR	1-1/2	25	0	086	20.54
878-020ESR	2	15	0	086	30.95

**Special Reinforced Reducing Female Adapter**  
Soc x SR Fipt - Stainless Steel Collar

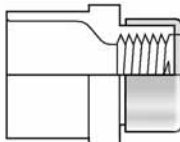

835-074SR	1/2X3/4	50	400	086	4.03
835-101SR	3/4X1/2	50	400	086	4.03
835-102SR	3/4X1	50	0	086	6.00
835-130SR	1X1/2	50	0	086	6.00
835-131SR	1X3/4	25	200	086	6.00

Part Number	Size	Std Pk	Mstr Ctn	Disc Code	Price Each
-------------	------	--------	----------	-----------	------------

**Special Reinforced Reducing Spigot Female Adapter**  
Spig x SR Fipt - Stainless Steel Collar

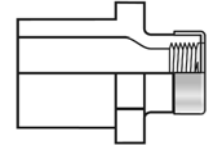

878-072SR	1/2X1/4	25	450	086	10.13
878-098SR	3/4X1/4	50	400	086	13.97
878-128SR	1X1/4	50	400	086	14.40

**Reinforced Male Adapter**  
R Mipt x Soc - Stainless Steel Sleeve

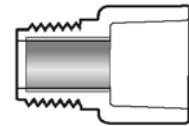

836-005R	1/2	25	150	086	3.43
836-007R	3/4	25	300	086	3.76
836-010R	1	10	60	086	6.59

**Special Reinforced Reducer Bushing**  
Mipt x SR Fipt - Stainless Steel Collar

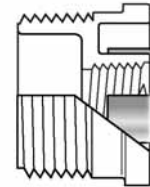

839-128SR	1X1/4	25	150	086	5.34
839-209SR	1-1/2X1/2	25	200	086	7.80
839-210SR	1-1/2X3/4	25	100	086	7.80
839-247SR	2X1/2	10	120	086	11.46
839-248SR	2X3/4	10	120	086	11.46
839-249SR	2X1	10	120	086	11.46
839-420SR	4X2	6	0	086	43.39

**Special Reinforced Reducer Bushing Flush Style**  
Spig x SR Fipt - Stainless Steel Collar

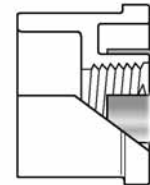

838-128SR	1X1/4	25	300	086	2.95
838-166SR	1-1/4X1/2	25	100	086	5.40
838-207SR	1-1/2X1/4	25	200	086	7.53
838-209SR	1-1/2X1/2	10	60	086	7.53
838-210SR	1-1/2X3/4	25	200	086	7.53
838-247SR	2X1/2	10	80	086	9.21
838-248SR	2X3/4	10	80	086	9.21
838-249SR	2X1	10	80	086	9.21

NOT FOR USE WITH COMPRESSED AIR OR GAS

# PVC Gray Special Reinforced (SR) Fittings



Part Number	Size	Std Pk	Mstr Ctn	Disc Code	Price Each
-------------	------	--------	----------	-----------	------------

### Special Reinforced Reducer Bushing Flush Style

Spig x SR Fipt - Stainless Steel Collar (continued)

838-334SR	3X3/4	10	0	086	36.06
838-335SR	3X1	10	0	086	36.06
838-336SR	3X1-1/4	10	0	086	36.06
838-337SR	3X1-1/2	10	0	086	36.06
838-528SR	6X2	5	0	086	63.84
838-530SR	6X3	5	0	086	57.46
838-532SR	6X4	5	0	086	63.84

### Special Reinforced Cap SR Fipt - Stainless Steel Collar

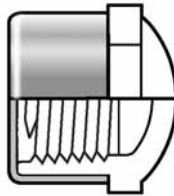

848-002SR	1/4	25	500	086	3.60
848-003SR	3/8	25	450	086	3.60
848-005SR	1/2	50	300	086	3.94
848-007SR	3/4	25	300	086	5.05
848-030SR	3	5	0	086	31.11

### Special Reinforced Union 2000 Soc x SR Fipt with EPDM O-ring Seal - Stainless Steel Collar

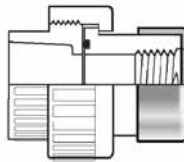

8099-005SR	1/2	20	160	086	7.14
8099-007SR	3/4	20	80	086	10.18
8099-010SR	1	15	90	086	13.13
8099-012SR	1-1/4	10	0	086	22.84
8099-015SR	1-1/2	10	0	086	29.60
8099-020SR	2	5	0	086	47.64
8099-025SR	2-1/2	5	0	086	101.91
8099-030SR	3	5	0	086	113.45
8099-040SR	4	4	0	086	129.48
8099-060SR	6	1	0	086	287.73

Part Number	Size	Std Pk	Mstr Ctn	Disc Code	Price Each
-------------	------	--------	----------	-----------	------------

### Special Reinforced Union 2000 Soc x SR Fipt with Viton® O-ring Seal - Stainless Steel Collar

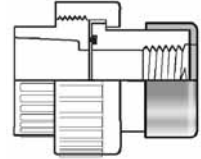

8059-005SR	1/2	20	160	086	7.43
8059-007SR	3/4	20	80	086	10.23
8059-010SR	1	15	90	086	13.29
8059-012SR	1-1/4	10	0	086	25.40
8059-015SR	1-1/2	10	0	086	31.34
8059-020SR	2	5	0	086	47.86
8059-025SR	2-1/2	5	0	086	102.86
8059-030SR	3	5	0	086	116.94
8059-040SR	4	4	0	086	134.26
8059-060SR	6	1	0	086	298.36

### Special Reinforced Union 2000 SR Fipt with EPDM O-ring Seal - Stainless Steel Collar

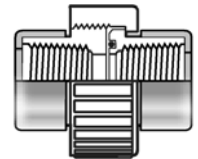

8098-005SR	1/2	20	120	086	7.53
8098-007SR	3/4	20	80	086	10.26
8098-010SR	1	15	90	086	13.57
8098-012SR	1-1/4	10	0	086	25.24
8098-015SR	1-1/2	10	0	086	31.74
8098-020SR	2	5	0	086	49.89
8098-025SR	2-1/2	5	0	086	100.68
8098-030SR	3	5	0	086	118.74
8098-040SR	4	4	0	086	136.32
8098-060SR	6	1	0	086	302.96

### Special Reinforced Union 2000 SR Fipt with Viton® O-ring Seal - Stainless Steel Collar

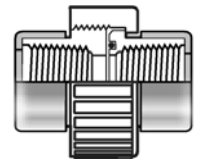

8058-005SR	1/2	20	120	086	7.64
8058-007SR	3/4	20	80	086	10.35
8058-010SR	1	15	90	086	13.85
8058-012SR	1-1/4	10	0	086	26.38
8058-015SR	1-1/2	10	0	086	32.46
8058-020SR	2	5	0	086	50.40
8058-025SR	2-1/2	5	0	086	105.39
8058-030SR	3	5	0	086	119.89
8058-040SR	4	4	0	086	141.13

NOT FOR USE WITH COMPRESSED AIR OR GAS

Made in the U.S.A.

Progressive Products from Spears® Innovation and Technology



# PVC Gray Special Reinforced (SR) Fittings

Part Number	Size	Std Pk	Mstr Ctn	Disc Code	Price Each
-------------	------	--------	----------	-----------	------------

**Special Reinforced Union 2000**  
**SR Fipt with Viton® O-ring Seal - Stainless Steel**  
**Collar (continued)**

8058-060SR	6	1	0	086	313.61
------------	---	---	---	-----	--------

**Special Reinforced Union (Old Style)**  
**Soc x SR Fipt with EPDM O-ring Seal -**  
**Stainless Steel Collar**

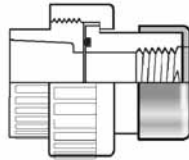

899-002SR	1/4	25	150	086	13.49
899-003SR	3/8	25	100	086	13.49
899-005SR	1/2	10	60	086	7.14
899-007SR	3/4	10	40	086	10.18
899-010SR	1	10	40	086	13.13
899-012SR	1-1/4	5	20	086	22.84
899-015SR	1-1/2	5	0	086	29.60
899-020SR	2	5	0	086	47.64
899-030SR	3	5	0	086	113.45
899-040SR	4	4	0	086	129.48

**Special Reinforced Union (Old Style)**  
**Soc x SR Fipt with Viton® O-ring Seal -**  
**Stainless Steel Collar**

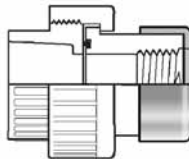

859-005SR	1/2	10	60	086	7.43
859-007SR	3/4	10	40	086	10.23
859-010SR	1	10	40	086	13.29
859-012SR	1-1/4	5	20	086	25.40
859-015SR	1-1/2	5	0	086	31.34
859-020SR	2	5	0	086	47.86
859-030SR	3	5	0	086	116.94
859-040SR	4	4	0	086	134.26

Part Number	Size	Std Pk	Mstr Ctn	Disc Code	Price Each
-------------	------	--------	----------	-----------	------------

**Special Reinforced Flange One Piece Threaded**  
**SR Fipt - Stainless Steel Collar**



852-005SR	1/2	25	0	086	10.63
852-007SR	3/4	25	0	086	12.49
852-010SR	1	15	0	086	13.66
852-012SR	1-1/4	15	0	086	18.82
852-015SR	1-1/2	15	0	086	20.60
852-020SR	2	10	0	086	21.09
852-025SR	2-1/2	10	0	086	48.31
852-030SR	3	10	0	086	49.74
852-040SR	4	5	0	086	93.49

**PVC New Style Special Reinforced (SR) Threaded Tank Adapters with Neoprene Gaskets**  
**Soc x SR Fipt - Stainless Steel Collar**

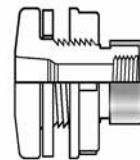

8171-002SR	1/4	25	150	100	31.77
8171-003SR	3/8	25	200	100	31.77
8171-005SR	1/2	25	0	100	31.77
8171-007SR	3/4	25	0	100	36.81
8171-010SR	1	25	0	100	41.45
8171-012SR	1-1/4	20	0	100	50.96
8171-015SR	1-1/2	20	0	100	58.49
8171-020SR	2	15	0	100	83.82
8171-025SR	2-1/2	4	0	100	134.96
8171-030SR	3	4	0	100	160.65
8171-040SR	4	2	0	100	297.15
8171-060SR	6	1	0	100	556.13

**PVC New Style Special Reinforced (SR) Threaded Tank Adapters with EPDM Gaskets**  
**Soc x SR Fipt - Stainless Steel Collar**

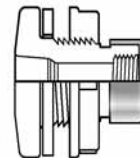

8171E-002SR	1/4	25	150	100	32.89
8171E-003SR	3/8	25	200	100	32.89
8171E-005SR	1/2	25	0	100	32.89
8171E-007SR	3/4	25	0	100	37.51
8171E-010SR	1	25	0	100	45.60

NOT FOR USE WITH COMPRESSED AIR OR GAS

Spears® Manufacturing Company

# PVC Gray Special Reinforced (SR) Fittings



Part Number	Size	Std Pk	Mstr Ctn	Disc Code	Price Each
-------------	------	--------	----------	-----------	------------

**PVC New Style Special Reinforced (SR) Threaded Tank Adapters with EPDM Gaskets Soc x SR Fipt - Stainless Steel Collar (continued)**

8171E-012SR	1-1/4	20	0	100	55.24
8171E-015SR	1-1/2	20	0	100	62.78
8171E-020SR	2	15	0	100	89.62
8171E-025SR	2-1/2	4	0	100	139.34
8171E-030SR	3	4	0	100	165.88
8171E-040SR	4	2	0	100	304.14
8171E-060SR	6	1	0	100	575.26

Part Number	Size	Std Pk	Mstr Ctn	Disc Code	Price Each
-------------	------	--------	----------	-----------	------------

**PVC New Style Special Reinforced (SR) Threaded Tank Adapters with Neoprene Gaskets Fipt x SR Fipt - Stainless Steel Collar (continued)**

8172-015SR	1-1/2	20	0	100	78.93
8172-020SR	2	15	0	100	102.27
8172-025SR	2-1/2	4	0	100	155.71
8172-030SR	3	4	0	100	185.38
8172-040SR	4	2	0	100	330.02
8172-060SR	6	1	0	100	638.39

**PVC New Style Special Reinforced (SR) Threaded Tank Adapters with Viton® Gaskets Soc x SR Fipt - Stainless Steel Collar**

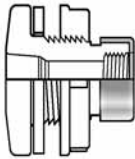

8171V-002SR	1/4	25	150	100	53.39
8171V-003SR	3/8	25	200	100	53.39
8171V-005SR	1/2	25	0	100	53.39
8171V-007SR	3/4	25	0	100	58.59
8171V-010SR	1	25	0	100	72.22
8171V-012SR	1-1/4	20	0	100	80.87
8171V-015SR	1-1/2	20	0	100	91.16
8171V-020SR	2	15	0	100	139.60
8171V-025SR	2-1/2	4	0	100	212.53
8171V-030SR	3	4	0	100	253.00
8171V-040SR	4	2	0	100	607.87
8171V-060SR	6	2	0	100	1077.33

**PVC New Style Special Reinforced (SR) Threaded Tank Adapters with EPDM Gaskets Fipt x SR Fipt - Stainless Steel Collar**

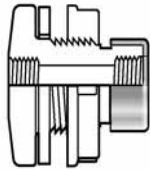

8172E-002SR	1/4	25	150	100	43.70
8172E-003SR	3/8	25	200	100	43.70
8172E-005SR	1/2	25	0	100	43.70
8172E-007SR	3/4	25	0	100	47.91
8172E-010SR	1	25	0	100	57.32
8172E-012SR	1-1/4	20	0	100	76.09
8172E-015SR	1-1/2	20	0	100	84.89
8172E-020SR	2	15	0	100	109.48
8172E-025SR	2-1/2	4	0	100	160.89
8172E-030SR	3	4	0	100	191.52
8172E-040SR	4	2	0	100	337.89
8172E-060SR	6	2	0	100	660.52

**PVC New Style Special Reinforced (SR) Threaded Tank Adapters with Neoprene Gaskets Fipt x SR Fipt - Stainless Steel Collar**

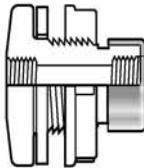

8172-002SR	1/4	25	150	100	42.48
8172-003SR	3/8	25	200	100	42.48
8172-005SR	1/2	25	0	100	42.48
8172-007SR	3/4	25	0	100	47.03
8172-010SR	1	25	0	100	52.01
8172-012SR	1-1/4	20	0	100	70.04

**PVC New Style Special Reinforced (SR) Threaded Tank Adapters with Viton® Gaskets Fipt x SR Fipt - Stainless Steel Collar**

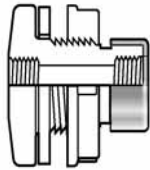

8172V-002SR	1/4	25	150	100	65.00
8172V-003SR	3/8	25	200	100	65.00
8172V-005SR	1/2	25	0	100	65.00
8172V-007SR	3/4	25	0	100	69.79
8172V-010SR	1	25	0	100	80.17
8172V-012SR	1-1/4	20	0	100	92.17
8172V-015SR	1-1/2	20	0	100	107.59

NOT FOR USE WITH COMPRESSED AIR OR GAS



# PVC Gray Special Reinforced (SR) Fittings

Part Number	Size	Std Pk	Mstr Ctn	Disc Code	Price Each
-------------	------	--------	----------	-----------	------------

**PVC New Style Special Reinforced (SR)  
Threaded Tank Adapters with Viton® Gaskets  
Fipt x SR Fipt - Stainless Steel Collar (continued)**

8172V-020SR	2	15	0	100	156.59
8172V-025SR	2-1/2	4	0	100	229.94
8172V-030SR	3	4	0	100	273.81
8172V-040SR	4	2	0	100	638.39
8172V-060SR	6	2	0	100	1205.46

**PVC Elastomer Expansion Joint  
with Neoprene Bellows SR Fipt -  
Stainless Steel Collar**



EJ01-007SR	3/4	10	0	085	179.15
EJ01-010SR	1	10	0	085	204.03
EJ01-012SR	1-1/4	15	0	085	221.91
EJ01-015SR	1-1/2	10	0	085	283.29
EJ01-020SR	2	8	0	085	340.35
EJ01-025SR	2-1/2	4	0	085	495.98
EJ01-030SR	3	2	0	085	667.01

**PVC Elastomer Expansion Joint  
with EPDM Bellows SR Fipt - Stainless  
Steel Collar**



EJ21-007SR	3/4	10	0	085	182.79
EJ21-010SR	1	10	0	085	208.19
EJ21-012SR	1-1/4	15	0	085	226.46
EJ21-015SR	1-1/2	10	0	085	289.05
EJ21-020SR	2	8	0	085	347.30
EJ21-025SR	2-1/2	4	0	085	503.29
EJ21-030SR	3	2	0	085	680.63

NOT FOR USE WITH COMPRESSED AIR OR GAS

# PVC Gray Brass Thread Fittings



Part Number	Size	Std Pk	Mstr Ctn	Disc Code	Price Each
-------------	------	--------	----------	-----------	------------

**Transition Tee  
Soc x Fipt With Brass Thread Insert**

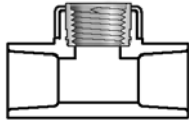

802-005BR	1/2	20	160	086	29.39
802-007BR	3/4	20	80	086	58.91
Not intended to convey or dispense water for human consumption through drinking or cooking					

**Transition Reducing Tee  
Soc x Fipt With Brass Thread Insert**

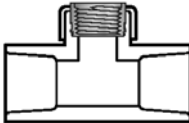

802-101BR	3/4X1/2	50	0	086	36.69
Not intended to convey or dispense water for human consumption through drinking or cooking					

**Transition 90° Ell  
Soc x Fipt With Brass Thread Insert**

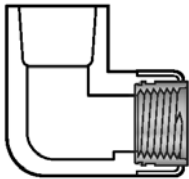

807-005BR	1/2	20	240	086	25.82
807-007BR	3/4	20	160	086	45.71
Not intended to convey or dispense water for human consumption through drinking or cooking					

**Transition Reducing 90° Ell  
Soc x Fipt With Brass Thread Insert**

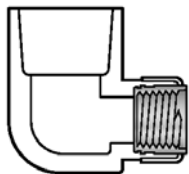

807-101BR	3/4X1/2	20	300	086	32.23
Not intended to convey or dispense water for human consumption through drinking or cooking					

Part Number	Size	Std Pk	Mstr Ctn	Disc Code	Price Each
-------------	------	--------	----------	-----------	------------

**Transition Female Adapter  
Soc x Fipt With Brass Thread Insert**

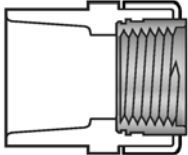

835-005BR	1/2	25	150	086	22.30
835-007BR	3/4	25	150	086	32.03
835-010BR	1	15	90	086	55.19
835-012BR	1-1/4	15	60	086	90.88
835-015BR	1-1/2	10	40	086	119.39
835-020BR	2	8	32	086	147.87

Not intended to convey or dispense water for human consumption through drinking or cooking

**Transition Female Adapter  
Spig x Fipt With Brass Thread Insert**

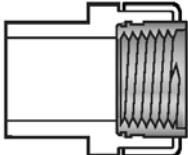

878-010BR	1	15	90	086	59.66
Not intended to convey or dispense water for human consumption through drinking or cooking					

**Transition Reducing Female Adapter  
Soc x Fipt With Brass Thread Insert**

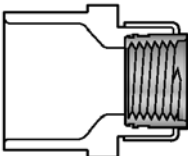

835-101BR	3/4X1/2	50	0	086	33.11
Not intended to convey or dispense water for human consumption through drinking or cooking					

**Transition Female Adapter  
Soc x Fipt With 316 Stainless Steel Thread Insert**

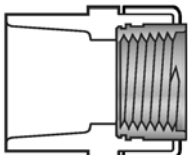

835-005SS	1/2	25	300	086	43.69
835-007SS	3/4	15	90	086	62.79
835-010SS	1	15	90	086	106.85
835-012SS	1-1/4	15	60	086	178.45
835-015SS	1-1/2	10	60	086	233.11
835-020SS	2	8	32	086	299.04

NOT FOR USE WITH COMPRESSED AIR OR GAS

Made in the U.S.A.

**Progressive Products from Spears® Innovation and Technology**



# PVC Gray Brass Thread Fittings

Part Number	Size	Std Pk	Mstr Ctn	Disc Code	Price Each
-------------	------	--------	----------	-----------	------------

**Transiton Male Adapter w/ Brass Thread**  
**Brass Mipt x Socket**



836-005BR	1/2	40	160	086	24.54
836-007BR	3/4	40	160	086	37.01
836-010BR	1	10	60	086	60.18
836-012BR	1-1/4	10	60	086	101.37
836-015BR	1-1/2	10	40	086	134.51
836-020BR	2	8	32	086	167.10

**Union**  
**Soc x Fipt with Brass Thread Insert & Viton® O-ring Seal**

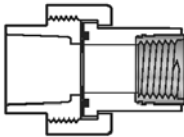

859-007BR	3/4	10	40	086	47.50
859-010BR	1	10	0	086	58.62
859-012BR	1-1/4	5	20	086	101.17
859-015BR	1-1/2	5	0	086	133.89
859-020BR	2	5	0	086	177.94

Not intended to convey or dispense water for human consumption through drinking or cooking

**Union**  
**Soc x Fipt with Brass Thread Insert & EPDM O-ring Seal**

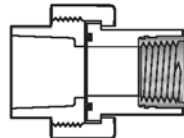

899-007BR	3/4	10	40	086	42.83
899-010BR	1	10	0	086	57.76
899-012BR	1-1/4	5	20	086	97.13
899-015BR	1-1/2	5	0	086	128.55
899-020BR	2	5	0	086	171.36

Not intended to convey or dispense water for human consumption through drinking or cooking

NOT FOR USE WITH COMPRESSED AIR OR GAS

# CPVC Gray Special Reinforced (SR) Fittings



Part Number	Size	Std Pk	Mstr Ctn	Disc Code	Price Each
-------------	------	--------	----------	-----------	------------

**Special Reinforced Tee**  
Soc x SR Fipt - Stainless Steel Collar

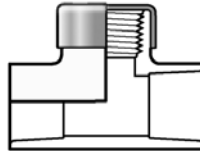

802-005CSR	1/2	50	0	096	17.57
802-007CSR	3/4	15	120	096	25.67
802-010CSR	1	15	0	096	32.30
802-012CSR	1-1/4	15	0	096	37.47
802-015CSR	1-1/2	10	0	096	37.47
802-030CSR	3	5	0	096	88.21
802-040CSR	4	5	0	096	166.18

**Special Reinforced Tee**  
SR Fipt - Stainless Steel Collar

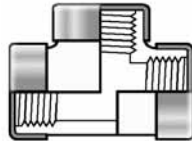

805-002CSR	1/4	20	160	096	15.72
805-003CSR	3/8	25	150	096	15.72
805-005CSR	1/2	25	150	096	21.03
805-007CSR	3/4	25	100	096	24.09
805-010CSR	1	15	0	096	35.98
805-015CSR	1-1/2	10	0	096	38.20
805-020CSR	2	10	0	096	45.49

**Special Reinforced Reducing Tee**  
Soc x SR Fipt - Stainless Steel Collar

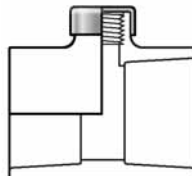

802-072CSR	1/2X1/4	25	200	096	17.57
802-098CSR	3/4X1/4	25	100	096	23.48
802-101CSR	3/4X1/2	50	0	096	23.48
802-128CSR <sup>1</sup>	1X1/4	15	0	096	36.26
802-130CSR	1X1/2	50	0	096	14.34
802-131CSR	1X3/4	15	0	086	36.26
802-164CSR <sup>1</sup>	1-1/4X1/4	5	0	096	48.21
802-166CSR	1-1/4X1/2	15	0	096	38.19
802-168CSR	1-1/4X1	10	0	096	38.97
802-207CSR <sup>1</sup>	1-1/2X1/4	15	0	096	69.03
802-211CSR	1-1/2X1	10	0	096	45.76
802-212CSR	1-1/2X1-1/4	10	0	096	45.76
802-245CSR <sup>1</sup>	2X1/4	10	0	096	79.30
802-247CSR	2X1/2	10	0	096	71.37
802-248CSR	2X3/4	10	0	096	79.30
802-287CSR	2-1/2X1/2	10	0	096	54.54

Part Number	Size	Std Pk	Mstr Ctn	Disc Code	Price Each
-------------	------	--------	----------	-----------	------------

**Special Reinforced Reducing Tee**  
Soc x SR Fipt - Stainless Steel Collar (continued)

802-331CSR <sup>1</sup>	3X1/4	5	0	096	151.47
802-413CSR <sup>1</sup>	4X1/4	5	0	096	164.37

<sup>1</sup> Sized with Bushing

**Special Reinforced Reducing Tee**  
Soc x SR Fipt - Stainless Steel Collar x Soc

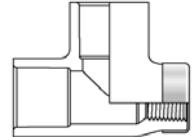

803-095CSR	3/4X1/2X3/4	15	0	096	14.47
------------	-------------	----	---	-----	-------

**Special Reinforced 90° Ell**  
Soc x SR Fipt - Stainless Steel Collar

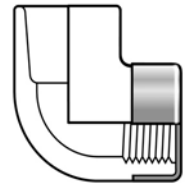

807-005CSR	1/2	20	240	096	8.53
807-007CSR	3/4	75	0	096	10.02
807-010CSR	1	50	0	096	12.06
807-012CSR	1-1/4	25	0	096	24.91
807-015CSR	1-1/2	10	0	090	29.94
807-020CSR	2	10	0	096	37.46

**Special Reinforced 90° Ell**  
SR Fipt - Stainless Steel Collar

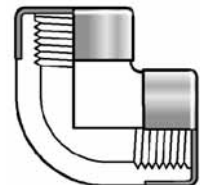

808-003CSR	3/8	25	150	096	5.15
808-005CSR	1/2	20	120	096	5.15
808-007CSR	3/4	20	160	096	7.55
808-010CSR	1	50	0	096	9.67
808-012CSR	1-1/4	25	0	096	18.61
808-015CSR	1-1/2	10	0	096	21.91
808-020CSR	2	10	0	096	29.36

NOT FOR USE WITH COMPRESSED AIR OR GAS

Made in the U.S.A.

**Progressive Products from Spears® Innovation and Technology**



# CPVC Gray Special Reinforced (SR) Fittings

Part Number	Size	Std Pk	Mstr Ctn	Disc Code	Price Each
-------------	------	--------	----------	-----------	------------

**Special Reinforced Reducing 90° EII**  
Soc x SR Fipt - Stainless Steel Collar

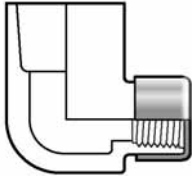

807-101CSR	3/4X1/2	50	0	096	10.87
807-130CSR	1X1/2	50	0	096	11.71

**Special Reinforced 45° EII**  
SR Fipt - Stainless Steel Collar

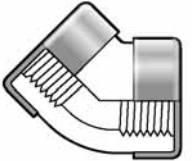

819-007CSR	3/4	10	120	096	11.78
------------	-----	----	-----	-----	-------

**Special Reinforced Coupling**  
SR Fipt - Stainless Steel Collar

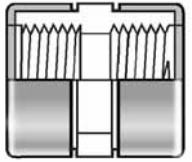

830-005CSR	1/2	25	300	096	8.31
830-007CSR	3/4	25	300	096	13.43
830-010CSR	1	25	200	096	15.26
830-012CSR	1-1/4	10	120	096	16.21
830-015CSR	1-1/2	10	80	096	17.38
830-020CSR	2	10	0	096	20.54

**Special Reinforced Reducer Coupling**  
SR Fipt - Stainless Steel Collar

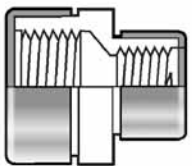

830-101CSR	3/4X1/2	50	200	096	14.90
830-130CSR	1X1/2	50	0	096	17.98
830-131CSR	1X3/4	25	200	096	17.98
830-168CSR	1-1/4X1	25	0	096	24.46
830-210CSR	1-1/2X3/4	25	0	096	34.98
830-211CSR	1-1/2X1	10	80	096	34.98
830-212CSR	1-1/2X1-1/4	10	80	096	34.98
830-249CSR	2X1	25	0	096	86.10
830-251CSR	2X1-1/2	15	0	096	86.10

Part Number	Size	Std Pk	Mstr Ctn	Disc Code	Price Each
-------------	------	--------	----------	-----------	------------

**Special Reinforced Female Adapter**  
Soc x SR Fipt - Stainless Steel Collar

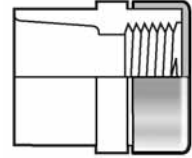

835-002CSR	1/4	25	450	096	11.67
835-003CSR	3/8	25	300	096	11.67
835-005CSR	1/2	25	300	096	5.01
835-007CSR	3/4	25	150	096	5.41
835-010CSR	1	25	200	096	12.34
835-012CSR	1-1/4	10	60	096	12.66
835-015CSR	1-1/2	10	80	096	14.70
835-020CSR	2	10	0	096	20.89
835-025CSR	2-1/2	5	0	096	48.57
835-030CSR	3	15	0	096	99.79
835-040CSR	4	5	0	096	166.09
835-060CSR	6	6	0	096	259.46

**Encapsulated Special Reinforced (SR) Female Adapter**  
Soc x ESR Fipt

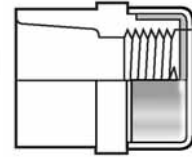

835-002CESR	1/4	25	450	096	14.80
835-003CESR	3/8	25	300	096	14.80
835-005CESR	1/2	25	300	096	7.68
835-007CESR	3/4	25	300	096	8.11
835-010CESR	1	25	200	096	17.87
835-012CESR	1-1/4	10	80	096	18.29
835-015CESR	1-1/2	10	0	096	23.68
835-020CESR	2	10	0	096	36.81

**Special Reinforced Spigot Female Adapter**  
Spig x SR Fipt - Stainless Steel Collar

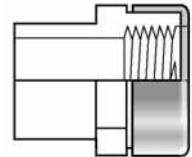

878-005CSR	1/2	50	600	096	5.34
878-007CSR	3/4	25	300	096	5.63
878-010CSR	1	50	0	096	12.67
878-012CSR	1-1/4	25	0	096	13.11
878-015CSR	1-1/2	25	0	096	15.22
878-020CSR	2	15	0	096	27.72
878-030CSR	3	5	0	096	101.04
878-040CSR	4	5	0	096	169.62

NOT FOR USE WITH COMPRESSED AIR OR GAS

# CPVC Gray Special Reinforced (SR) Fittings



Part Number	Size	Std Pk	Mstr Ctn	Disc Code	Price Each
-------------	------	--------	----------	-----------	------------

**Special Reinforced Reducing Female Adapter**  
Soc x SR Fipt - Stainless Steel Collar

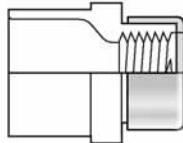

835-074CSR	1/2X3/4	50	400	096	5.41
835-101CSR	3/4X1/2	50	400	096	5.41
835-102CSR	3/4X1	50	0	096	12.34
835-130CSR	1X1/2	50	0	096	12.34
835-131CSR	1X3/4	25	200	096	12.34

**Encapsulated Special Reinforced (SR) Female Adapter**  
Spig x ESR Fipt

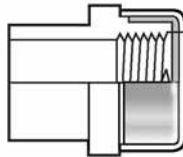

878-005CESR	1/2	50	600	096	7.91
878-007CESR	3/4	25	300	096	8.41
878-010CESR	1	50	0	096	18.04
878-012CESR	1-1/4	25	0	096	18.53
878-015CESR	1-1/2	25	0	096	24.16
878-020CESR	2	15	0	096	37.34

**Special Reinforced Reducing Spigot Female Adapter**  
Spig x SR Fipt - Stainless Steel Collar

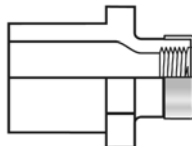

878-072CSR	1/2X1/4	25	450	096	15.30
878-098CSR	3/4X1/4	50	400	096	17.81
878-128CSR	1X1/4	50	400	096	19.94

**Reinforced Male Adapter**  
R Mipt x Soc - Stainless Steel Sleeve

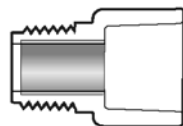

836-005CR	1/2	25	150	096	7.70
836-007CR	3/4	25	300	096	8.82
836-010CR	1	10	120	096	10.45

Part Number	Size	Std Pk	Mstr Ctn	Disc Code	Price Each
-------------	------	--------	----------	-----------	------------

**Special Reinforced Reducing Bushing**  
Mipt x SR Fipt - Stainless Steel Collar

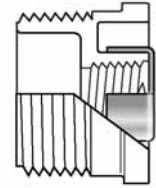

839-209CSR	1-1/2X1/2	25	200	096	19.74
839-210CSR	1-1/2X3/4	25	100	096	19.74
839-247CSR	2X1/2	10	120	096	21.82
839-248CSR	2X3/4	10	120	096	21.82
839-249CSR	2X1	10	120	096	21.82
839-420CSR	4X2	6	0	096	121.15

**Special Reinforced Reducer Bushing**  
Spig x SR Fipt - Stainless Steel Collar

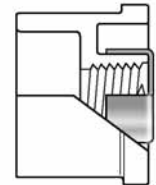

838-128CSR	1X1/4	25	300	096	11.37
838-207CSR	1-1/2X1/4	25	200	096	19.24
838-209CSR	1-1/2X1/2	10	120	096	20.06
838-210CSR	1-1/2X3/4	10	120	096	20.06
838-247CSR	2X1/2	10	80	096	27.56
838-248CSR	2X3/4	10	80	096	27.56
838-249CSR	2X1	10	80	096	27.56
838-334CSR	3X3/4	10	0	096	116.70
838-335CSR	3X1	10	0	096	116.70
838-336CSR	3X1-1/4	10	0	096	116.70
838-337CSR	3X1-1/2	10	0	096	116.70
838-528CSR	6X2	5	0	096	401.20
838-530CSR	6x3	5	0	096	401.20

**Special Reinforced Cap**  
SR Fipt - Stainless Steel Collar

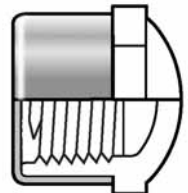

848-002CSR	1/4	25	500	096	6.31
848-003CSR	3/8	25	450	096	6.31
848-007CSR	3/4	25	300	096	9.82
848-030CSR	3	5	0	096	109.66

NOT FOR USE WITH COMPRESSED AIR OR GAS



# CPVC Gray Special Reinforced (SR) Fittings

Part Number	Size	Std Pk	Mstr Ctn	Disc Code	Price Each
-------------	------	--------	----------	-----------	------------

**Special Reinforced Union 2000**  
**Soc x SR Fipt with EPDM O-ring Seal -**  
**Stainless Steel Collar**

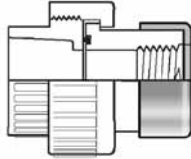

8099-005CSR	1/2	20	160	096	14.12
8099-007CSR	3/4	20	160	096	25.07
8099-010CSR	1	15	90	096	34.71
8099-012CSR	1-1/4	10	0	096	65.76
8099-015CSR	1-1/2	10	0	096	71.52
8099-020CSR	2	5	0	096	75.31
8099-025CSR	2-1/2	5	0	096	129.18
8099-030CSR	3	5	0	096	209.81
8099-040CSR	4	4	0	096	246.40
8099-060CSR	6	1	0	096	547.59

**Special Reinforced Union 2000**  
**SR Fipt with Viton® O-ring Seal -**  
**Stainless Steel Collar**

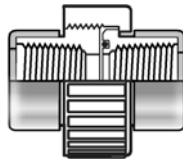

8058-005CSR	1/2	20	160	096	14.78
8058-007CSR	3/4	20	80	096	25.77
8058-010CSR	1	15	90	096	35.41
8058-012CSR	1-1/4	10	0	096	66.74
8058-015CSR	1-1/2	10	0	096	72.83
8058-020CSR	2	5	0	096	76.74
8058-030CSR	3	5	0	096	216.87
8058-040CSR	4	4	0	096	254.06
8058-060CSR	6	1	0	096	572.17

**Special Reinforced Union 2000**  
**SR Fipt with EPDM O-ring Seal -**  
**Stainless Steel Collar**

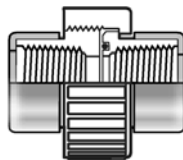

8098-005CSR	1/2	20	160	096	14.29
8098-007CSR	3/4	20	80	096	25.53
8098-010CSR	1	15	90	096	35.01
8098-012CSR	1-1/4	10	0	096	66.09
8098-015CSR	1-1/2	10	0	096	72.27
8098-020CSR	2	5	0	096	75.99
8098-025CSR	2-1/2	5	0	096	131.32
8098-030CSR	3	5	0	096	213.51
8098-040CSR	4	4	0	096	247.17

Part Number	Size	Std Pk	Mstr Ctn	Disc Code	Price Each
-------------	------	--------	----------	-----------	------------

**Special Reinforced Union 2000**  
**SR Fipt with EPDM O-ring Seal - Stainless Steel**  
**Collar (continued)**

8098-060CSR	6	1	0	096	549.28
-------------	---	---	---	-----	--------

**Special Reinforced Union (Old Style)**  
**Soc x SR Fipt with EPDM O-ring Seal -**  
**Stainless Steel Collar**

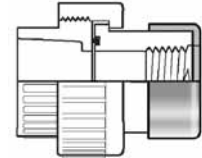

899-002CSR	1/4	25	150	096	22.51
899-003CSR	3/8	25	100	096	22.51
899-005CSR	1/2	10	60	096	14.12
899-007CSR	3/4	10	40	096	25.07
899-010CSR	1	10	40	096	34.71
899-012CSR	1-1/4	5	20	096	65.76
899-015CSR	1-1/2	5	0	096	71.52
899-020CSR	2	5	0	096	75.31
899-030CSR	3	5	0	096	209.81
899-040CSR	4	4	0	096	246.40

**Special Reinforced Union (Old Style)**  
**Soc x SR Fipt with Viton® O-ring Seal -**  
**Stainless Steel Collar**

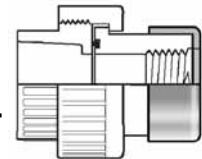

859-002CSR	1/4	25	150	096	22.66
859-003CSR	3/8	25	100	096	22.66
859-005CSR	1/2	10	60	096	14.40
859-007CSR	3/4	10	40	096	25.41
859-010CSR	1	10	40	096	35.01
859-012CSR	1-1/4	5	20	096	66.74
859-015CSR	1-1/2	5	0	096	72.55
859-020CSR	2	5	0	096	75.53
859-030CSR	3	5	0	096	212.48
859-040CSR	4	4	0	096	247.90

NOT FOR USE WITH COMPRESSED AIR OR GAS

# CPVC Gray Special Reinforced (SR) Fittings



Part Number	Size	Std Pk	Mstr Ctn	Disc Code	Price Each
-------------	------	--------	----------	-----------	------------

## Special Reinforced Flange One Piece Threaded SR Fipt - Stainless Steel Collar

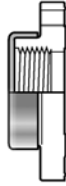

852-005CSR	1/2	25	0	096	18.44
852-007CSR	3/4	25	0	096	22.37
852-010CSR	1	15	0	096	24.48
852-012CSR	1-1/4	15	0	096	33.87
852-015CSR	1-1/2	15	0	096	35.91
852-020CSR	2	10	0	096	36.78
852-025CSR	2-1/2	10	0	090	59.18
852-030CSR	3	10	0	096	58.72
852-040CSR	4	5	0	096	91.24

## CPVC New Style Special Reinforced (SR) Threaded Tank Adapters with Neoprene Gaskets Soc x SR Fipt - Stainless Steel Collar

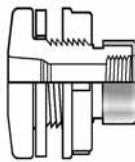

8171-002CSR	1/4	25	150	101	44.47
8171-003CSR	3/8	25	200	101	44.47
8171-005CSR	1/2	25	0	101	44.47
8171-007CSR	3/4	25	0	101	53.22
8171-010CSR	1	25	0	101	60.21
8171-012CSR	1-1/4	20	0	101	77.66
8171-015CSR	1-1/2	20	0	101	87.19
8171-020CSR	2	15	0	101	120.57
8171-025CSR	2-1/2	4	0	101	183.41
8171-030CSR	3	4	0	101	218.31
8171-040CSR	4	2	0	101	350.85
8171-060CSR	6	1	0	101	926.62

## CPVC New Style Special Reinforced (SR) Threaded Tank Adapters with EPDM Gaskets Soc x SR Fipt - Stainless Steel Collar

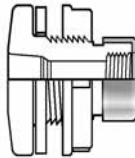

8171E-002CSR	1/4	25	150	101	50.40
8171E-003CSR	3/8	25	200	101	50.40
8171E-005CSR	1/2	25	0	101	50.40
8171E-007CSR	3/4	25	0	101	56.96
8171E-010CSR	1	25	0	101	68.11
8171E-012CSR	1-1/4	20	0	101	85.12
8171E-015CSR	1-1/2	20	0	101	92.09

Part Number	Size	Std Pk	Mstr Ctn	Disc Code	Price Each
-------------	------	--------	----------	-----------	------------

## CPVC New Style Special Reinforced (SR) Threaded Tank Adapters with EPDM Gaskets Soc x SR Fipt - Stainless Steel Collar (continued)

8171E-020CSR	2	15	0	101	130.19
8171E-025CSR	2-1/2	4	0	101	191.32
8171E-030CSR	3	4	0	101	227.76
8171E-040CSR	4	2	0	101	365.17
8171E-060CSR	6	2	0	101	964.37

## CPVC New Style Special Reinforced (SR) Threaded Tank Adapters with Viton® Gaskets Soc x SR Fipt - Stainless Steel Collar

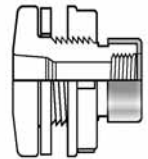

8171V-002CSR	1/4	25	150	101	65.67
8171V-003CSR	3/8	25	200	101	65.67
8171V-005CSR	1/2	25	0	101	65.67
8171V-007CSR	3/4	25	0	101	75.91
8171V-010CSR	1	25	0	101	88.31
8171V-012CSR	1-1/4	20	0	101	109.47
8171V-015CSR	1-1/2	20	0	101	116.90
8171V-020CSR	2	15	0	101	174.07
8171V-025CSR	2-1/2	4	0	101	256.53
8171V-030CSR	3	4	0	101	305.45
8171V-040CSR	4	2	0	101	652.21
8171V-060CSR	6	2	0	101	1610.28

## CPVC New Style Special Reinforced (SR) Threaded Tank Adapters with Neoprene Gaskets Fipt x SR Fipt - Stainless Steel Collar

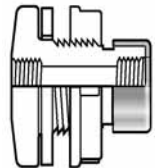

8172-002CSR	1/4	25	150	101	58.91
8172-003CSR	3/8	25	200	101	58.91
8172-005CSR	1/2	25	0	101	58.91
8172-007CSR	3/4	25	0	101	68.41
8172-010CSR	1	25	0	101	75.38
8172-012CSR	1-1/4	20	0	101	106.93
8172-015CSR	1-1/2	20	0	101	119.46
8172-020CSR	2	15	0	101	147.70
8172-025CSR	2-1/2	4	0	101	214.37
8172-030CSR	3	4	0	101	255.20

NOT FOR USE WITH COMPRESSED AIR OR GAS

Made in the U.S.A.

Progressive Products from Spears® Innovation and Technology

Page 20



# CPVC Gray Special Reinforced (SR) Fittings

Part Number	Size	Std Pk	Mstr Ctn	Disc Code	Price Each
-------------	------	--------	----------	-----------	------------

**CPVC New Style Special Reinforced (SR) Threaded Tank Adapters with Neoprene Gaskets**

**Fipt x SR Fipt - Stainless Steel Collar (continued)**

8172-040CSR	4	2	0	101	391.96
8172-060CSR	6	2	0	101	1050.14

**CPVC New Style Special Reinforced (SR) Threaded Tank Adapters with EPDM Gaskets**  
**Fipt x SR Fipt - Stainless Steel Collar**

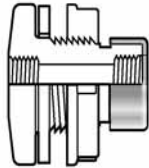

8172E-002CSR	1/4	25	150	101	61.21
8172E-003CSR	3/8	25	200	101	61.21
8172E-005CSR	1/2	25	0	101	61.21
8172E-007CSR	3/4	25	0	101	72.48
8172E-010CSR	1	25	0	101	78.69
8172E-012CSR	1-1/4	20	0	101	111.07
8172E-015CSR	1-1/2	20	0	101	129.13
8172E-020CSR	2	15	0	101	158.49
8172E-025CSR	2-1/2	4	0	101	239.09
8172E-030CSR	3	4	0	101	284.62
8172E-040CSR	4	2	0	101	460.78
8172E-060CSR	6	2	0	101	1065.68

**CPVC New Style Special Reinforced (SR) Threaded Tank Adapters with Viton® Gaskets**  
**Fipt x SR Fipt - Stainless Steel Collar**

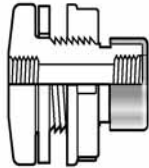

8172V-002CSR	1/4	25	150	101	94.00
8172V-003CSR	3/8	25	200	101	94.00
8172V-005CSR	1/2	25	0	101	94.00
8172V-007CSR	3/4	25	0	101	106.34
8172V-010CSR	1	25	0	101	122.81
8172V-012CSR	1-1/4	20	0	101	151.63
8172V-015CSR	1-1/2	20	0	101	159.70
8172V-020CSR	2	15	0	101	245.43
8172V-025CSR	2-1/2	4	0	101	354.64
8172V-030CSR	3	4	0	101	422.20
8172V-040CSR	4	2	0	101	1077.32
8172V-060CSR	6	2	0	101	1956.14

Part Number	Size	Std Pk	Mstr Ctn	Disc Code	Price Each
-------------	------	--------	----------	-----------	------------

**CPVC Elastomer Expansion Joint**

**with EPDM Bellows SR Fipt - Stainless Steel Collar**



EJ21-007CSR	3/4	10	0	085	185.94
EJ21-010CSR	1	10	0	085	213.83
EJ21-012CSR	1-1/4	15	0	085	236.29
EJ21-015CSR	1-1/2	10	0	085	301.19
EJ21-020CSR	2	8	0	085	398.11
EJ21-025CSR	2-1/2	4	0	085	552.88
EJ21-030CSR	3	2	0	085	736.37

NOT FOR USE WITH COMPRESSED AIR OR GAS

# CPVC Gray Brass Thread Fittings



Part Number	Size	Std Pk	Mstr Ctn	Disc Code	Price Each
-------------	------	--------	----------	-----------	------------

## Transition Tee Soc x Fipt With Brass Thread Insert

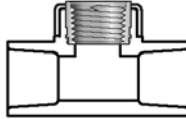

802-005CBR	1/2	20	160	096	52.13
802-007CBR	3/4	25	0	096	104.26
Not intended to convey or dispense water for human consumption through drinking or cooking					

## Transition Reducing Tee Soc x Fipt With Brass Thread Insert

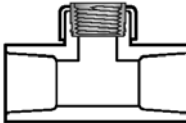

802-101CBR	3/4X1/2	50	0	096	64.62
Not intended to convey or dispense water for human consumption through drinking or cooking					

## Transition 90° Ell Soc x Fipt With Brass Thread Insert

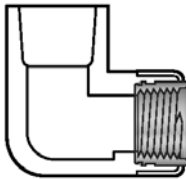

807-005CBR	1/2	20	240	096	45.83
807-007CBR	3/4	20	160	096	80.02
Not intended to convey or dispense water for human consumption through drinking or cooking					

## Transition Reducing 90° Ell Soc x Fipt With Brass Thread Insert

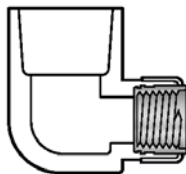

807-101CBR	3/4X1/2	20	120	096	57.32
Not intended to convey or dispense water for human consumption through drinking or cooking					

Part Number	Size	Std Pk	Mstr Ctn	Disc Code	Price Each
-------------	------	--------	----------	-----------	------------

## Transition Female Adapter Soc x Fipt With Brass Thread Insert

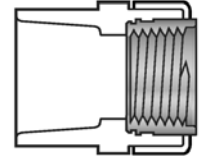

835-005CBR	1/2	25	150	096	28.26
835-007CBR	3/4	15	90	096	58.48
835-010CBR	1	15	90	096	102.62
835-012CBR	1-1/4	15	60	096	167.41
835-015CBR	1-1/2	10	80	096	220.73
835-020CBR	2	8	32	096	275.68

Not intended to convey or dispense water for human consumption through drinking or cooking

## Transition Female Adapter Soc x Fipt With Type 316 Stainless Steel Thread Insert

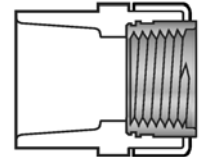

835-005CSS	1/2	25	150	096	55.48
835-007CSS	3/4	15	90	096	77.46
835-010CSS	1	15	90	096	135.57
835-012CSS	1-1/4	15	0	096	220.32
835-015CSS	1-1/2	10	60	096	287.43
835-020CSS	2	8	32	096	336.38

## Transition Male Adapter w/Brass Thread Brass Mipt x Socket



836-005CBR	1/2	40	160	096	62.63
836-007CBR	3/4	40	160	096	88.18
836-010CBR	1	10	60	096	153.59
836-012CBR	1-1/4	10	60	096	249.82
836-020CBR	2	8	32	096	380.60

## Union Soc x Fipt with Brass Thread Insert & Viton® O-ring Seal

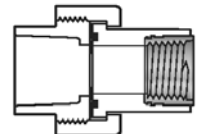

859-007CBR	3/4	10	20	096	130.53
859-010CBR	1	10	0	096	145.38
859-012CBR	1-1/4	5	0	096	243.70

NOT FOR USE WITH COMPRESSED AIR OR GAS

Made in the U.S.A.

Progressive Products from Spears® Innovation and Technology

Page 22



# CPVC Gray Brass Thread Fittings

Part Number	Size	Std Pk	Mstr Ctn	Disc Code	Price Each
-------------	------	--------	----------	-----------	------------

**Union**

**Soc x Fipt with Brass Thread Insert & Viton® O-ring**

**Seal (continued)**

859-015CBR	1-1/2	5	0	096	276.94
859-020CBR	2	5	0	096	313.00

Not intended to convey or dispense water for human consumption through drinking or cooking

**Union**

**Soc x Fipt with Brass Thread Insert & EPDM O-ring Seal**

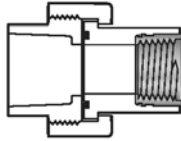

899-007CBR	3/4	10	40	096	128.32
899-010CBR	1	10	0	096	143.59
899-012CBR	1-1/4	5	20	096	240.63
899-015CBR	1-1/2	5	0	096	273.41
899-020CBR	2	5	0	096	309.17

Not intended to convey or dispense water for human consumption through drinking or cooking

NOT FOR USE WITH COMPRESSED AIR OR GAS

# CPVC Orange Special Reinforced (SR) Fittings



The CPVC Orange fittings in this section (4200 series part numbers) are approved by Underwriters Laboratories, FM Global, and LPCB for use in CPVC Fire Sprinkler Systems. When installed in these systems, installation must be made in accordance with Spears® publication FG-3, *FlameGuard™ CPVC Fire Sprinkler Products Installation Instructions*, and local codes. However, these fittings can also be used in many other types of installations, such as hot water distribution. CPVC fittings may also be used on PVC pipe when installed with a quality CPVC solvent cement meeting the requirements of ASTM F 493, Standard Specification for Solvent Cements for Chlorinated Poly(Vinyl Chloride)(CPVC) Plastic Pipe and Fittings.

Part Number	Size	Std Pk	Mstr Ctn	Disc Code	Price Each
-------------	------	--------	----------	-----------	------------

**Sprinkler Head Tee - Special Reinforced Plastic Thread Style with Wrench Flats**  
**Socket x Socket x SR FIPT - Zinc Collar**

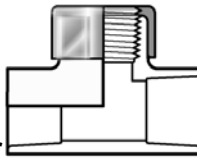

4202-010SR	1	15	0	076	19.38
4202-130SR	1X1/2	50	0	076	7.55

**Sprinkler Head Tee - Special Reinforced Plastic Thread Style Socket x Socket x SR FIPT - Stainless Steel Collar**

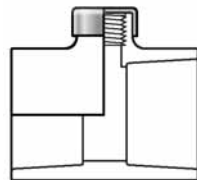

4202-101SR	3/4X1/2	50	0	076	6.99
4202-124SR	1X3/4X1/2	50	0	076	7.55
4202-156SR	1-1/4X1X1/2	15	0	076	12.59
4202-166SR	1-1/4X1/2	15	0	076	12.59
4202-168SR	1-1/4X1	15	0	076	27.06
4202-199SR	1-1/2X1-1/4X1/2	10	0	076	16.57
4202-209SR	1-1/2X1/2	25	0	076	16.57
4202-211SR	1-1/2X1-1/2X1	10	0	076	16.57
4202-237SR	2X1-1/2X1/2	10	0	076	23.38
4202-247SR	2X1/2	10	0	076	23.38
4202-287SR	2-1/2X1/2	10	0	076	32.04

**Sprinkler Head Tee - Special Reinforced Plastic Thread Style Socket x SR FIPT x Socket - Stainless Steel Collar**

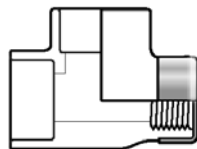

4203-122SR	1X1/2X1	50	0	076	8.11
------------	---------	----	---	-----	------

Part Number	Size	Std Pk	Mstr Ctn	Disc Code	Price Each
-------------	------	--------	----------	-----------	------------

**Sprinkler Head 90° Ell - Special Reinforced Plastic Thread Style Socket x SR FIPT - Stainless Steel Collar**

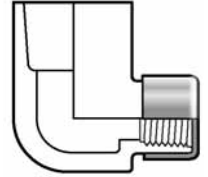

4207-101SR	3/4X1/2	20	180	076	4.61
4207-130SR	1X1/2	10	150	076	6.50
4207-131SR	1X3/4	50	0	076	7.86
4207-166SR	1-1/4X1/2	25	0	076	8.26

**Female Adapter - Special Reinforced Plastic Thread Style Socket x SR FIPT - Stainless Steel Collar**

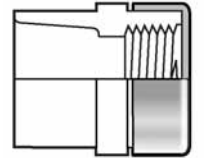

4235-007SR	3/4	25	300	076	8.22
4235-010SR <sup>1</sup>	1	25	200	076	14.45
4235-012SR	1-1/4	10	60	076	23.52

1-Zinc Collar

**Female Sprinkler Head Adapter - Special Reinforced Plastic Thread Style Socket x SR FIPT - Stainless Steel Collar**

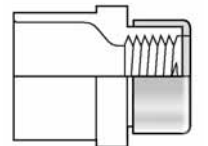

4235-101SR	3/4X1/2	50	200	076	5.02
4235-130SR	1X1/2	50	0	076	5.37
4235-131SR	1X3/4	50	0	076	8.50

**Female Sprinkler Head Adapter - Special Reinforced Plastic Thread Style with Socket Body Wrench Flats Socket x SR FIPT - Stainless Steel Collar**

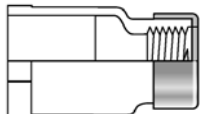

W4235-101SR	3/4X1/2	50	0	076	5.73
W4235-130SR	1X1/2	50	0	076	6.13

NOT FOR USE WITH COMPRESSED AIR OR GAS

Made in the U.S.A.

Progressive Products from Spears® Innovation and Technology

Page 24



# CPVC Orange Special Reinforced (SR) Fittings

Part Number	Size	Std Pk	Mstr Ctn	Disc Code	Price Each
-------------	------	--------	----------	-----------	------------

**Female Sprinkler Head Adapter - Special Reinforced Plastic Thread with Metal Thread Start Socket x SR FIPT - Zinc Collar**

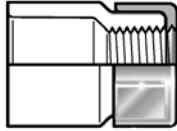

Z4235-101SR	3/4X1/2	50	200	076	5.02
Z4235-130SR	1X1/2	50	0	076	5.37

Part Number	Size	Std Pk	Mstr Ctn	Disc Code	Price Each
-------------	------	--------	----------	-----------	------------

**Spigot Female Adapter - Special Reinforced Plastic Thread Style Spigot x SR FIPT - Stainless Steel Collar**

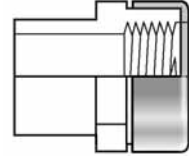

4278-007SR	3/4	25	300	076	8.63
4278-010SR	1	50	0	076	15.36

**Female Sprinkler Head Adapter - Special Reinforced Plastic Thread Style with Positioning Ring Socket x SR FIPT - Stainless Steel Collar**

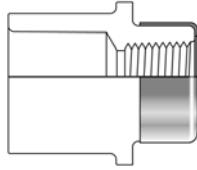

R4235-101SR	3/4X1/2	25	300	076	5.67
-------------	---------	----	-----	-----	------

**Spigot Female Sprinkler Head Adapters - Special Reinforced Plastic Threaded Style Spigot x SR FIPT - Stainless Steel Collar**

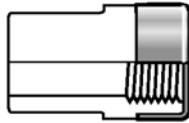

4238-101SR	3/4X1/2	50	400	076	5.02
4238-130SR	1X1/2	50	0	076	5.43

**Adjustable Sprinkler Head Adapters - Special Reinforced Plastic Thread Style Socket x SR FIPT - Zinc Collar**



42001SR	3/4X1/2	12	0	076	12.82
42011SR	1X1/2	12	0	076	12.82

**Adjustable Sprinkler Head Adapters - Special Reinforced Plastic Thread Style Spigot x SR FIPT - Zinc Collar**



42004SR	3/4X1/2	12	0	076	12.82
42014SR	1X1/2	12	0	076	12.82

NOT FOR USE WITH COMPRESSED AIR OR GAS

# CPVC Orange Brass Thread Fittings



The CPVC Orange fittings in this section (4200 series part numbers) are approved by Underwriters Laboratories, FM Global, and LPCB for use in CPVC Fire Sprinkler Systems. When installed in these systems, installation must be made in accordance with Spears® publication FG-3, *FlameGuard™ CPVC Fire Sprinkler Products Installation Instructions*, and local codes. However, these fittings can also be used in many other types of installations, such as hot water distribution. CPVC fittings may also be used on PVC pipe when installed with a quality CPVC solvent cement meeting the requirements of ASTM F 493, Standard Specification for Solvent Cements for Chlorinated Poly(Vinyl Chloride)(CPVC) Plastic Pipe and Fittings.

Part Number	Size	Std Pk	Mstr Ctn	Disc Code	Price Each
-------------	------	--------	----------	-----------	------------

## Sprinkler Head Tee - Brass Thread Insert Style Socket x Socket x FIPT

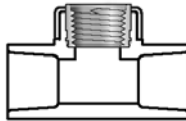

4202-101	3/4X1/2	50	0	076	13.14
4202-124	1X3/4X1/2	50	0	076	14.18
4202-130	1X1/2	50	0	076	14.18
4202-010	1	10	40	076	36.47
4202-156	1-1/4X1X1/2	15	0	076	23.65
4202-166	1-1/4X1/2	15	0	076	23.65
4202-199	1-1/2X1-1/4X1/2	10	0	076	31.15
4202-209	1-1/2X1/2	10	0	076	31.15
4202-237	2X1-1/2X1/2	10	0	076	43.93
4202-247	2X1/2	10	0	076	43.93

Not intended to convey or dispense water for human consumption through drinking or cooking

## Sprinkler Head Tee - Brass Thread Insert Style Socket x FIPT x Socket

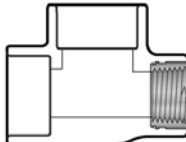

4203-122	1X1/2X1	50	0	076	23.29
----------	---------	----	---	-----	-------

Not intended to convey or dispense water for human consumption through drinking or cooking

## Sprinkler Head 90° Ell - Brass Thread Insert Style Socket x FIPT

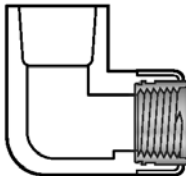

4207-101	3/4X1/2	20	120	076	8.68
4207-130	1X1/2	15	90	076	12.20
4207-131	1X3/4	25	0	076	14.76
4207-166	1-1/4X1/2	10	60	076	16.99

Not intended to convey or dispense water for human consumption through drinking or cooking

Part Number	Size	Std Pk	Mstr Ctn	Disc Code	Price Each
-------------	------	--------	----------	-----------	------------

## Female Adapter - Brass Thread Insert Style Socket x FIPT

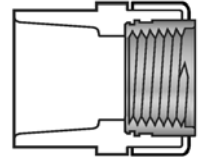

4235-007	3/4	15	90	076	17.32
4235-010	1	15	90	076	30.39
4235-012	1-1/4	15	60	076	49.54
4235-015	1-1/2	10	40	076	66.09
4235-020	2	8	32	076	82.83

Not intended to convey or dispense water for human consumption through drinking or cooking

## Spigot Female Adapter - Brass Thread Insert Style Spigot x FIPT

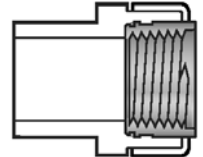

4278-007	3/4	25	150	076	16.20
4278-010	1	15	90	076	28.85

Not intended to convey or dispense water for human consumption through drinking or cooking

## TorqueSafe™ Female Sprinkler Head Adapter - Gasket Sealed Brass Thread Insert Style Socket x Gasket FIPT

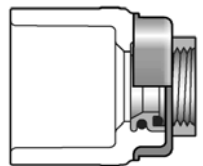

4235-130GS	1X1/2	50	0	076	13.54
------------	-------	----	---	-----	-------

FIPT With Elastomer Seal - Use NO Thread Sealant

Not intended to convey or dispense water for human consumption through drinking or cooking

NOT FOR USE WITH COMPRESSED AIR OR GAS

Made in the U.S.A.

Progressive Products from Spears® Innovation and Technology

Page 26



# CPVC Orange Brass Thread Fittings

Part Number	Size	Std Pk	Mstr Ctn	Disc Code	Price Each
-------------	------	--------	----------	-----------	------------

**Female Sprinkler Head Adapter - Brass Thread Insert Style**  
Socket x FIPT

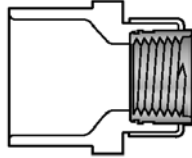

4235-101	3/4X1/2	50	0	076	9.46
4235-130	1X1/2	50	0	076	10.10
4235-131	1X3/4	50	0	076	15.96

Not intended to convey or dispense water for human consumption through drinking or cooking

**Female Sprinkler Head Adapter - Brass Thread Insert Style with Long Body**  
Socket x FIPT

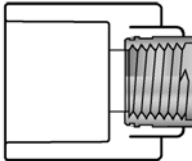

L4235-130	1X1/2	50	0	076	14.32
-----------	-------	----	---	-----	-------

Not intended to convey or dispense water for human consumption through drinking or cooking

**Female Sprinkler Head Adapter - Brass Thread Insert Style with Positioning Ring**  
Socket x FIPT

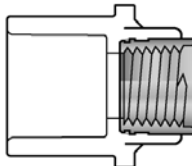

R4235-101	3/4X1/2	50	0	076	9.46
-----------	---------	----	---	-----	------

Not intended to convey or dispense water for human consumption through drinking or cooking

**Spigot Female Sprinkler Head Adapters - Brass Thread Insert Style**  
Spigot x FIPT

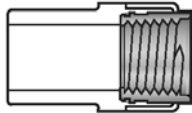

4238-101	3/4X1/2	50	0	076	9.46
4238-130	1X1/2	50	0	076	10.10

Not intended to convey or dispense water for human consumption through drinking or cooking

Part Number	Size	Std Pk	Mstr Ctn	Disc Code	Price Each
-------------	------	--------	----------	-----------	------------

**Bushing - with Brass Thread Insert**  
Spigot x FIPT

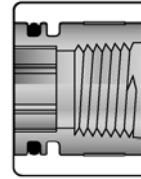

4238-130BR	1X1/2	50	300	076	13.07
------------	-------	----	-----	-----	-------

Not intended to convey or dispense water for human consumption through drinking or cooking

**Male Adapter**  
MIPT x Socket

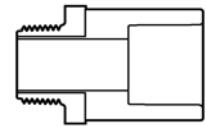

4236-007	3/4	40	160	076	20.87
4236-010	1	10	60	076	24.60
4236-012	1-1/4	10	60	076	27.11
4236-015	1-1/2	10	40	076	29.85
4236-020	2	8	32	076	40.95

NOT FOR USE WITH COMPRESSED AIR OR GAS

# CPVC Orange Brass Grooved Coupling Adapter



Part Number	Size	Std Pk	Mstr Ctn	Disc Code	Price Each
-------------	------	--------	----------	-----------	------------

## Grooved Coupling Adapter Brass Groove End x Socket

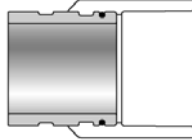

4233-012	1-1/4	10	40	076	97.98
4233-015	1-1/2	10	40	076	103.84
4233-020	2	8	32	076	120.27

Not intended to convey or dispense water for human consumption through drinking or cooking

NOT FOR USE WITH COMPRESSED AIR OR GAS

Made in the U.S.A.

Progressive Products from Spears® Innovation and Technology

Page 28



# CTS CPVC Tan Special Reinforced (SR) Fittings

Part Number	Size	Std Pk	Mstr Ctn	Disc Code	Price Each
-------------	------	--------	----------	-----------	------------

**SPECIAL REINFORCED 90° ELL**  
**Socket x SR Fipt - Stainless Steel**  
**Collar**

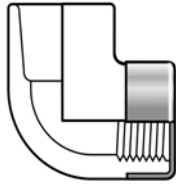

4107-005SR	1/2	50	300	035	4.88
------------	-----	----	-----	-----	------

**ZINC DROP EAR REINFORCED**  
**CTS 90° ELL (One Piece Unit)**  
**Socket x SR Fipt - Zinc Collar**

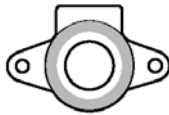

DEZ4107-005SR	1/2	10	150	035	10.97
---------------	-----	----	-----	-----	-------

**DROP EAR SPECIAL**  
**REINFORCED 90° ELL (Fitting**  
**Plus Bracket)**  
**Socket x SR Fipt - Stainless Steel**  
**Collar**

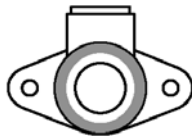

DE4107-005SR	1/2	10	200	035	4.56
--------------	-----	----	-----	-----	------

**SPECIAL REINFORCED FEMALE**  
**ADAPTER**  
**Socket x SR Fipt - Stainless Steel**  
**Collar**

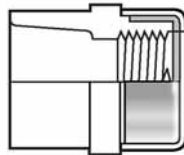

4135-005SR	1/2	25	200	035	3.77
4135-007SR	3/4	25	300	035	4.15
4135-010SR	1	5	100	035	8.67

**SPECIAL REINFORCED**  
**REDUCING FEMALE ADAPTER**  
**Socket x SR Fipt - Stainless Steel**  
**Collar**

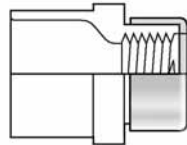

4135-131SR	1X3/4	25	150	035	8.27
------------	-------	----	-----	-----	------

Part Number	Size	Std Pk	Mstr Ctn	Disc Code	Price Each
-------------	------	--------	----------	-----------	------------

**REINFORCED MALE ADAPTER**  
**(Internal Stainless Steel**  
**Reinforced)**  
**R Mipt x Socket - Stainless Steel**  
**Sleeve**

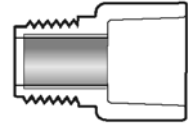

4136-005R	1/2	25	300	035	4.83
4136-007R	3/4	25	300	035	5.38
4136-010R	1	10	120	035	8.01

NOT FOR USE WITH COMPRESSED AIR OR GAS

# CTS CPVC Tan Brass Thread Fittings



Part Number	Size	Std Pk	Mstr Ctn	Disc Code	Price Each
-------------	------	--------	----------	-----------	------------

## TRANSITION FEMALE ADAPTER Socket x Fipt with Brass Thread Insert

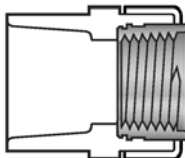

4135-005BR	1/2	25	150	035	16.69
4135-007BR	3/4	25	150	035	25.72
4135-010BR	1	15	90	035	35.46
4135-012BR	1-1/4	15	60	035	108.66
4135-015BR	1-1/2	10	40	035	141.63
4135-020BR	2	8	32	035	208.24

## TRANSITION REDUCING FEMALE ADAPTER Socket x Fipt with Brass Thread Insert

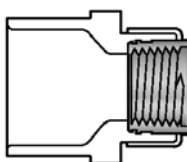

4135-101BR	3/4X1/2	25	150	035	18.95
4135-130BR	1X1/2	50	0	035	31.77

## TRANSITION MALE ADAPTER w/BRASS THREAD Brass Mipt x Socket

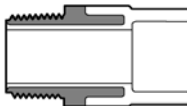

4136-005BR	1/2	60	360	035	17.03
4136-007BR	3/4	40	160	035	26.07
4136-010BR	1	10	60	035	35.78
4136-012BR	1-1/4	10	60	035	88.17
4136-015BR	1-1/2	10	40	035	116.41
4136-020BR	2	8	32	035	193.48

NOT FOR USE WITH COMPRESSED AIR OR GAS

Made in the U.S.A.

Progressive Products from Spears® Innovation and Technology

Page 30



# CTS CPVC Tan Gasket Sealed Thread Fittings

Part Number	Size	Std Pk	Mstr Ctn	Disc Code	Price Each
-------------	------	--------	----------	-----------	------------

**FEMALE ADAPTER with Gasket**  
Socket x NPSC

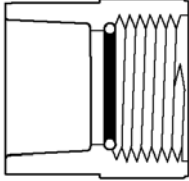

4135-005OR	1/2	25	200	035	2.55
4135-007OR	3/4	25	300	035	3.62
4135-010OR	1	5	100	035	4.13

NOT FOR USE WITH COMPRESSED AIR OR GAS

Spears® Manufacturing Company

# Blue 75™ Thread Sealant



Part Number	Size	Std Pk	Mstr Ctn	Disc Code	Price Each
-------------	------	--------	----------	-----------	------------



**Blue 75™ Thread Sealant**

SB75-005	1/4 Pint	24	0	895	9.34
SB75-010	1/2 Pint	24	0	895	14.88
SB75-020	Pint	12	0	895	24.05
SB75-030	Quart	12	0	895	43.23



## Special Reinforced (SR) & Metal Thread Transition Fittings & Adapters

### CONTENT

#### CATALOG INFORMATION

TRANSITION FITTINGS OVERVIEW	1
APPROVALS	1
HOW TO USE THIS CATALOG	2
ORGANIZATION	2
PAGE & COLUMN HEADER INFORMATION	2
PRODUCT CONFIGURATION	2

#### PVC White Special Reinforced (SR) Fittings

Special Reinforced Female Adapter Soc x SR Fipt - Stainless Steel Collar	3
Special Reinforced Tee Soc x SR Fipt - Stainless Steel Collar	3
Special Reinforced Reducing Tee Soc x SR Fipt - Stainless Steel Collar	3
Special Reinforced Reducing Tee Soc x SR Fipt-Stainless Steel Collar x Soc	3
Special Reinforced 90° Ell & Reducing 90° Ell Soc x SR Fipt - Stainless Steel Collar	3
Special Reinforced Coupling SR Fipt - Stainless Steel Collar	3
Special Reinforced Reducer Coupling SR Fipt - Stainless Steel Collar	4
Special Reinforced Spigot Female Adapter Spig x SR Fipt - Stainless Steel Collar	4
Special Reinforced Reducing Spigot Female Adapter Spig x SR Fipt - Stainless Steel Collar	4
Special Reinforced Reducing Female Adapter Soc x SR Fipt - Stainless Steel Collar	4
Special Reinforced Reducer Bushing Flush Style Spig x SR Fipt - Stainless Steel Collar	4
Special Reinforced Reducer Bushing Flush Style Mipt x SR Fipt - Stainless Steel Collar	4
Special Reinforced Cap SR Fipt - Stainless Steel Collar	4
Special Reinforced Union Soc x SR Fipt with Buna O-ring Seal - Stainless Steel Collar	5
Special Reinforced Union Soc x SR Fipt with EPDM O-ring Seal - Stainless Steel Collar	5

#### PVC White Brass Thread Fittings

Transition Union Soc x Fipt with Brass Thread Insert & Buna-N O-ring Seal	6
Transition Union Soc x Fipt with Brass Thread Insert & EPDM O-ring Seal	6

#### PVC Gray Special Reinforced (SR) Fittings

Special Reinforced Tee Soc x SR Fipt - Stainless Steel Collar	7
Special Reinforced Tee SR Fipt - Stainless Steel Collar	7
Special Reinforced Reducing Tee Soc x SR Fipt - Stainless Steel Collar	7
Special Reinforced Reducing Tee Soc x SR Fipt - Stainless Steel Collar x Soc	7
Special Reinforced 90° Ell Soc x SR Fipt - Stainless Steel Collar	7
Special Reinforced 90° Ell SR Fipt - Stainless Steel Collar	7
Special Reinforced Reducing 90° Ell Soc x SR Fipt - Stainless Steel Collar	8
Special Reinforced 45° Ell SR Fipt - Stainless Steel Collar	8
Special Reinforced Coupling SR Fipt - Stainless Steel Collar	8
Special Reinforced Reducer Coupling SR Fipt - Stainless Steel Collar	8
Special Reinforced Female Adapter Soc x SR Fipt - Stainless Steel Collar	8

# Special Reinforced (SR) & Metal Thread Transition Fittings & Adapters



## CONTENT

Encapsulated Special Reinforced Female Adapter Soc x ESR Fipt	8
Special Reinforced Spigot Female Adapter Spig x SR Fipt - Stainless Steel Collar	9
Encapsulated Special Reinforced Spigot Female Adapter Spig x ESR Fipt	9
Special Reinforced Reducing Female Adapter Soc x SR Fipt - Stainless Steel Collar	9
Special Reinforced Reducing Spigot Female Adapter Spig x SR Fipt - Stainless Steel Collar	9
Reinforced Male Adapter R Mipt x Soc - Stainless Steel Sleeve	9
Special Reinforced Reducer Bushing Mipt x SR Fipt - Stainless Steel Collar	9
Special Reinforced Reducer Bushing Flush Style Spig x SR Fipt - Stainless Steel Collar	9
Special Reinforced Cap SR Fipt - Stainless Steel Collar	10
Special Reinforced Union 2000 Soc x SR Fipt with EPDM O-ring Seal - Stainless Steel Collar	10
Special Reinforced Union 2000 Soc x SR Fipt with Viton® O-ring Seal - Stainless Steel Collar	10
Special Reinforced Union 2000 SR Fipt with EPDM O-ring Seal - Stainless Steel Collar	10
Special Reinforced Union 2000 SR Fipt with Viton® O-ring Seal - Stainless Steel Collar	10
Special Reinforced Union (Old Style) Soc x SR Fipt with EPDM O-ring Seal - Stainless Steel Collar	11
Special Reinforced Union (Old Style) Soc x SR Fipt with Viton® O-ring Seal - Stainless Steel Collar	11
Special Reinforced Flange One Piece Threaded SR Fipt - Stainless Steel Collar	11
PVC New Style Special Reinforced (SR) Threaded Tank Adapters with Neoprene Gaskets Soc x SR Fipt - Stainless Steel Collar	11
PVC New Style Special Reinforced (SR) Threaded Tank Adapters with EPDM Gaskets Soc x SR Fipt - Stainless Steel Collar	11
PVC New Style Special Reinforced (SR) Threaded Tank Adapters with Viton® Gaskets Soc x SR Fipt - Stainless Steel Collar	12
PVC New Style Special Reinforced (SR) Threaded Tank Adapters with Neoprene Gaskets Fipt x SR Fipt - Stainless Steel Collar	12
PVC New Style Special Reinforced (SR) Threaded Tank Adapters with EPDM Gaskets Fipt x SR Fipt - Stainless Steel Collar	12
PVC New Style Special Reinforced (SR) Threaded Tank Adapters with Viton® Gaskets Fipt x SR Fipt - Stainless Steel Collar	12
PVC Elastomer Expansion Joint with Neoprene Bellows SR Fipt - Stainless Steel Collar	13
PVC Elastomer Expansion Joint with EPDM Bellows SR Fipt - Stainless Steel Collar	13
<b>PVC Gray Brass Thread Fittings</b>	
Transition Tee Soc x Fipt With Brass Thread Insert	14
Transition Reducing Tee Soc x Fipt With Brass Thread Insert	14
Transition 90° Ell Soc x Fipt With Brass Thread Insert	14
Transition Reducing 90° Ell Soc x Fipt With Brass Thread Insert	14
Transition Female Adapter Soc x Fipt With Brass Thread Insert	14
Transition Female Adapter Spig x Fipt With Brass Thread Insert	14
Transition Reducing Female Adapter Soc x Fipt With Brass Thread Insert	14
Transition Female Adapter Soc x Fipt With 316 Stainless Steel Thread Insert	14



## Special Reinforced (SR) & Metal Thread Transition Fittings & Adapters

### CONTENT

Transition Male Adapter w/ Brass Thread Brass Mipt x Socket	15
Union Soc x Fipt with Brass Thread Insert & Viton® O-ring Seal	15
Union Soc x Fipt with Brass Thread Insert & EPDM O-ring Seal	15
<b>CPVC Gray Special Reinforced (SR) Fittings</b>	
Special Reinforced Tee Soc x SR Fipt - Stainless Steel Collar	16
Special Reinforced Tee SR Fipt - Stainless Steel Collar	16
Special Reinforced Reducing Tee Soc x SR Fipt - Stainless Steel Collar	16
Special Reinforced Reducing Tee Soc x SR Fipt - Stainless Steel Collar x Soc	16
Special Reinforced 90° Ell Soc x SR Fipt - Stainless Steel Collar	16
Special Reinforced 90° Ell SR Fipt - Stainless Steel Collar	16
Special Reinforced Reducing 90° Ell Soc x SR Fipt - Stainless Steel Collar	17
Special Reinforced 45° Ell SR Fipt - Stainless Steel Collar	17
Special Reinforced Coupling SR Fipt - Stainless Steel Collar	17
Special Reinforced Reducer Coupling SR Fipt - Stainless Steel Collar	17
Special Reinforced Female Adapter Soc x SR Fipt - Stainless Steel Collar	17
Encapsulated Special Reinforced (SR) Female Adapter Soc x ESR Fipt	17
Special Reinforced Spigot Female Adapter Spig x SR Fipt - Stainless Steel Collar	17
Special Reinforced Reducing Female Adapter Soc x SR Fipt - Stainless Steel Collar	18
Encapsulated Special Reinforced (SR) Female Adapter Spig x ESR Fipt	18
Special Reinforced Reducing Spigot Female Adapter Spig x SR Fipt - Stainless Steel Collar	18
Reinforced Male Adapter R Mipt x Soc - Stainless Steel Sleeve	18
Special Reinforced Reducing Bushing Mipt x SR Fipt - Stainless Steel Collar	18
Special Reinforced Reducer Bushing Spig x SR Fipt - Stainless Steel Collar	18
Special Reinforced Cap SR Fipt - Stainless Steel Collar	18
Special Reinforced Union 2000 Soc x SR Fipt with EPDM O-ring Seal - Stainless Steel Collar	19
Special Reinforced Union 2000 Soc x SR Fipt with EPDM O-ring Seal - Stainless Steel Collar	19
Special Reinforced Union 2000 SR Fipt with Viton® O-ring Seal - Stainless Steel Collar	19
Special Reinforced Union 2000 SR Fipt with EPDM O-ring Seal - Stainless Steel Collar	19
Special Reinforced Union (Old Style) Soc x SR Fipt with EPDM O-ring Seal - Stainless Steel Collar	19
Special Reinforced Union (Old Style) Soc x SR Fipt with Viton® O-ring Seal - Stainless Steel Collar	19
Special Reinforced Flange One Piece Threaded SR Fipt - Stainless Steel Collar	20
CPVC New Style Special Reinforced (SR) Threaded Tank Adapters with Neoprene Gaskets Soc x SR Fipt - Stainless Steel Collar	20
CPVC New Style Special Reinforced (SR) Threaded Tank Adapters with EPDM Gaskets Soc x SR Fipt - Stainless Steel Collar	20
CPVC New Style Special Reinforced (SR) Threaded Tank Adapters with Viton® Gaskets Soc x SR Fipt - Stainless Steel Collar	20
CPVC New Style Special Reinforced (SR) Threaded Tank Adapters with Neoprene Gaskets Fipt x SR Fipt - Stainless Steel Collar	20

# Special Reinforced (SR) & Metal Thread Transition Fittings & Adapters



## CONTENT

CPVC New Style Special Reinforced (SR) Threaded Tank Adapters with EPDM Gaskets Fipt x SR Fipt - Stainless Steel Collar	21
CPVC New Style Special Reinforced (SR) Threaded Tank Adapters with Viton® Gaskets Fipt x SR Fipt - Stainless Steel Collar	21
CPVC Elastomer Expansion Joint with EPDM Bellows SR Fipt - Stainless Steel Collar	21

### CPVC Gray Brass Thread Fittings

Transition Tee Soc x Fipt With Brass Thread Insert	22
Transition Reducing Tee Soc x Fipt With Brass Thread Insert	22
Transition 90° Ell Soc x Fipt With Brass Thread Insert	22
Transition Reducing 90° Ell Soc x Fipt With Brass Thread Insert	22
Transition Female Adapter Soc x Fipt With Brass Thread Insert	22
Transition Female Adapter Soc x Fipt With Type 316 Stainless Steel Thread Insert	22
Transition Male Adapter w/Brass Thread Brass Mipt x Socket	22
Union Soc x Fipt with Brass Thread Insert & Viton® O-ring Seal	22
Union Soc x Fipt with Brass Thread Insert & EPDM O-ring Seal	23

### CPVC Orange Special Reinforced (SR) Fittings

Sprinkler Head Tee - Special Reinforced Plastic Thread Style with Wrench Flats Socket x Socket x SR FIPT - Zinc Collar	24
Sprinkler Head Tee - Special Reinforced Plastic Thread Style Socket x Socket x SR FIPT - Stainless Steel Collar	24
Sprinkler Head Tee - Special Reinforced Plastic Thread Style Socket x SR FIPT x Socket - Stainless Steel Collar	24
Sprinkler Head 90° Ell - Special Reinforced Plastic Thread Style Socket x SR FIPT - Stainless Steel Collar	24
Female Adapter - Special Reinforced Plastic Thread Style Socket x SR FIPT - Stainless Steel Collar	24
Female Sprinkler Head Adapter - Special Reinforced Plastic Thread Style Socket x SR FIPT - Stainless Steel Collar	24
Female Sprinkler Head Adapter - Special Reinforced Plastic Thread Style with Socket Body Wrench Flats Socket x SR FIPT - Stainless Steel Collar	24
Female Sprinkler Head Adapter - Special Reinforced Plastic Thread with Metal Thread Start Socket x SR FIPT - Zinc Collar	25
Female Sprinkler Head Adapter - Special Reinforced Plastic Thread Style with Positioning Ring Socket x SR FIPT - Stainless Steel Collar	25
Spigot Female Sprinkler Head Adapters - Special Reinforced Plastic Threaded Style Spigot x SR FIPT - Stainless Steel Collar	25
Adjustable Sprinkler Head Adapters - Special Reinforced Plastic Thread Style Socket x SR FIPT - Zinc Collar	25
Adjustable Sprinkler Head Adapters - Special Reinforced Plastic Thread Style Spigot x SR FIPT - Zinc Collar	25



## Special Reinforced (SR) & Metal Thread Transition Fittings & Adapters

### CONTENT

Spigot Female Adapter - Special Reinforced Plastic Thread Style Spigot x SR FIPT - Stainless Steel Collar 25

#### CPVC Orange Brass Thread Fittings

Sprinkler Head Tee - Brass Thread Insert Style Socket x Socket x FIPT 26

Sprinkler Head Tee - Brass Thread Insert Style Socket x FIPT x Socket 26

Sprinkler Head 90° Ell - Brass Thread Insert Style Socket x FIPT 26

Female Adapter - Brass Thread Insert Style Socket x FIPT 26

Spigot Female Adapter - Brass Thread Insert Style Spigot x FIPT 26

TorqueSafe™ Female Sprinkler Head Adapter - Gasket Sealed Brass Thread Insert Style Socket x Gasket FIPT 26

Female Sprinkler Head Adapter - Brass Thread Insert Style Socket x FIPT 27

Female Sprinkler Head Adapter - Brass Thread Insert Style with Long Body Socket x FIPT 27

Female Sprinkler Head Adapter - Brass Thread Insert Style with Positioning Ring Socket x FIPT 27

Spigot Female Sprinkler Head Adapters - Brass Thread Insert Style Spigot x FIPT 27

Bushing - with Brass Thread Insert Spigot x FIPT 27

Male Adapter MIPT x Socket 27

#### CPVC Orange Brass Grooved Coupling Adapter

Grooved Coupling Adapter Brass Groove End x Socket 28

#### CTS CPVC Tan Special Reinforced (SR) Fittings

SPECIAL REINFORCED 90° ELL Socket x SR Fipt - Stainless Steel Collar 29

ZINC DROP EAR REINFORCED CTS 90° ELL (One Piece Unit) Socket x SR Fipt - Zinc Collar 29

DROP EAR SPECIAL REINFORCED 90° ELL (Fitting Plus Bracket) Socket x SR Fipt - Stainless Steel Collar 29

SPECIAL REINFORCED FEMALE ADAPTER Socket x SR Fipt - Stainless Steel Collar 29

SPECIAL REINFORCED REDUCING FEMALE ADAPTER Socket x SR Fipt - Stainless Steel Collar 29

REINFORCED MALE ADAPTER (Internal Stainless Steel Reinforced) R Mipt x Socket - Stainless Steel Sleeve 29

#### CTS CPVC Tan Brass Thread Fittings

TRANSITION FEMALE ADAPTER Socket x Fipt with Brass Thread Insert 30

TRANSITION REDUCING FEMALE ADAPTER Socket x Fipt with Brass Thread Insert 30

TRANSITION MALE ADAPTER w/BRASS THREAD Brass Mipt x Socket 30

#### CTS CPVC Tan Gasket Sealed Thread Fittings

FEMALE ADAPTER with Gasket Socket x NPSC 31

#### Blue 75™ Thread Sealant

Blue 75™ Thread Sealant 32

# NOTES

## The Spears® Quality Policy

It is the policy and objective of Spears® Manufacturing Company to produce a superior quality product suitable for its intended use, with regard to functionality, structural integrity, and conformance to established industry standards and practices. It is the commitment of this Company to do so in a manner which provides consistency of product quality, optimum availability, and superior customer service, while maintaining efficiency of operations and profitability necessary to perpetuate product improvement and customer satisfaction. Furthermore, it is recognized that the attainment of these objectives is the responsibility of all Company operations and personnel according to their respective functions.



### SPEARS® MANUFACTURING COMPANY • CORPORATE OFFICE

15853 Olden St., Sylmar, CA 91342 • PO Box 9203, Sylmar, CA 91392  
(818) 364-1611 • [www.spearsmfg.com](http://www.spearsmfg.com)



#### PACIFIC SOUTHWEST

15860 Olden St.  
Sylmar (Los Angeles), CA 91342  
(818) 364-1611 • (800) 862-1499  
Fax (818) 367-3014

#### ROCKY MOUNTAIN

4880 Florence St.  
Denver, CO 80238  
(303) 371-9430 • (800) 777-4154  
Fax (303) 375-9546

#### UTAH

5395 West 1520 South  
Salt Lake City, UT 84104  
(303) 371-9430 • (800) 777-4154  
Fax (303) 375-9546

#### SOUTHEAST

4205 Newpoint Pl., Suite 100  
Lawrenceville (Atlanta), GA 30043  
(678) 985-1263 • (800) 662-6326  
Fax (678) 985-5642

#### MIDWEST

1 Gateway Ct., Suite A  
Bolingbrook (Chicago), IL 60440  
(630) 759-7529 • (800) 662-6330  
Fax (630) 759-7515

#### NORTHWEST

4103 C St. NE Suite 200  
Auburn (Seattle), WA 98002  
(253) 939-4433 • (800) 347-7327  
Fax (253) 939-7557

#### SOUTH CENTRAL

1000 Lakeside Parkway  
Flower Mound, TX 75028  
(469) 528-3000 • (800) 441-1437  
Fax (469) 528-3001

#### NORTHEAST

590 Industrial Dr., Suite 100  
Lewisberry (Harrisburg), PA 17339-9532  
(717) 938-8844 • (800) 233-0275  
Fax (717) 938-6547

#### FLORIDA

9563 Parksouth Court  
Orlando, FL 32837  
(407) 843-1960 • (800) 327-6390  
Fax (407) 425-3563

#### INTERNATIONAL SALES

15853 Olden St.  
Sylmar (Los Angeles), CA 91342  
(818) 364-1611 • Fax (818) 898-3774