



Schedule 40 Fittings & Accessories Filters

Specially designed for agricultural and irrigation applications. Suitable for any application where cool, filtered water is required. Standard units utilize an internal-to-external filter cartridge. See following page for reverse flow (external to internal) filters.



- 200 psi Working Pressure Non-Shock @ 73°F (23°C)
- Filter Body is made from NSF®-PW Approved PVC Material
- Optional Screen Meshes
- Compact Design, Easy to Clean
- Lightweight, Easy to Install

- Filter Screens are designed using a standard perforated Stainless Steel Screen
- Mesh Sizes include an inner Stainless Steel Cloth with Spring Support (external cloth on reverse flow filters)
- Pressure loss: 100 GPM – 3 psi 50 GPM – 1.25 psi
- May be bushed to required pipe size

- When more than 100 gpm is required, filters may be installed in parallel
- When installing filter, allow space for removing filter screen for cleaning
- Remove stainless steel filter screen before solvent welding filter to pipe manifold
- When filters are installed in the direct sun, it is suggested the filter body be coated with a water-base latex paint having a high reflectance
- Installation in a shaded area is preferred

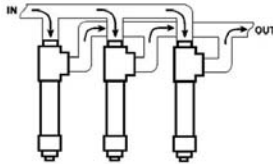

—CAUTION—

- WATER HAMMER MAY CAUSE SEVERE DAMAGE TO THE FILTER ASSEMBLY.
- BACK FLUSHING IS NOT RECOMMENDED.
- QUALITY GRADE THREAD SEALANT IS RECOMMENDED FOR ALL THREADED PVC CONNECTIONS.

Mesh Size	Hole Size (in.)	Part Number Extension
1/16" Holes	.0625	-16
1/32" Holes	.0312	-32
50 Mesh	.0117	-50
76 Mesh	.0095	-76
100 Mesh	.0059	-100
150 Mesh	.0041	-150
200 Mesh	.0029	-200

Additional Mesh Sizes available on request.

Filter Dimensions & Weights

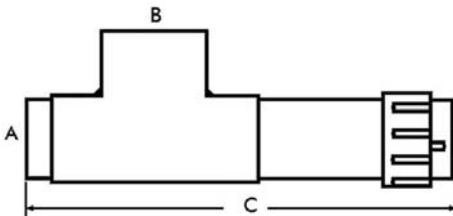

Series	A Inlet		B Outlet	C Overall Length	Screen Length	Filter Approx. Weight
	Socket	Spigot				
FLR	2-1/2	3	4	28	24	8
MFLR	2-1/2	3	4	16	12	4-3/4

Filter Assembly with Stainless Steel Screen

Part Number	Size	Std Pk	Mstr Ctn	Disc Code	Price Each
100 GPM					
FL-16*	2-1/2 1/3 x 4	1	0	020	555.11
FL-32*	2-1/2 1/3 x 4	1	0	020	567.73
FL-50	2-1/2 1/3 x 4	1	0	020	643.40
FL-76	2-1/2 1/3 x 4	1	0	020	777.14
FL-100	2-1/2 1/3 x 4	1	0	020	706.48
FL-150	2-1/2 1/3 x 4	1	0	020	731.74
FL-200	2-1/2 1/3 x 4	1	0	020	794.81

*Standard FL-16 and FL-32 can be utilized as Reverse Flow Filters by reversing installation from current inlet to outlet and current outlet to inlet.

NOTE: Filter Assemblies are furnished standard with a 1-1/4" IPS tapped cap (FL4a) for use with a valve, or may be plugged off (plug not furnished). Optional cap available with 1/4" IPS tapping for use with a pressure gauge — specify FL-5a when ordering.

50 GPM

Part Number	Size	Std Pk	Mstr Ctn	Disc Code	Price Each
MFL-16*	2-1/2 1/3 x 2	1	0	020	466.82
MFL-32*	2-1/2 1/3 x 2	1	0	020	474.37
MFL-50	2-1/2 1/3 x 2	1	0	020	489.48
MFL-76	2-1/2 1/3 x 2	1	0	020	592.98
MFL-100	2-1/2 1/3 x 2	1	0	020	517.27
MFL-150	2-1/2 1/3 x 2	1	0	020	542.49
MFL-200	2-1/2 1/3 x 2	1	0	020	605.57

*Standard FL-16 and FL-32 can be utilized as Reverse Flow Filters by reversing installation from current inlet to outlet and current outlet to inlet.

NOTE: Filter Assemblies are furnished standard with a 1-1/4" IPS tapped cap (FL4a) for use with a valve, or may be plugged off (plug not furnished). Optional cap available with 1/4" IPS tapping for use with a pressure gauge — specify FL-5a when ordering.

Filter Replacement Screens

Part Number	Size	Std Pk	Mstr Ctn	Disc Code	Price Each
100 GPM (24" Length)					
FL-16-1	1/16" Holes	3	0	020	222.04
FL-32-1	1/32" Holes	3	0	020	242.22
FL-50-1	50 Mesh	3	0	020	479.42

Filter Replacement Screens (continued)

Part Number	Size	Std Pk	Mstr Ctn	Disc Code	Price Each
100 GPM (24" Length)					
FL-76-1	76 Mesh	3	0	020	474.37
FL-100-1	100 Mesh	3	0	020	373.45
FL-150-1	150 Mesh	3	0	020	403.71
FL-200-1	200 Mesh	3	0	020	499.60

NOTE: When ordering replacement screens for FL and MFL Series Filters, please provide exact length of old screen within 1/64" to ensure proper fit of new screen in your filter body.

50 GPM (12" Length)

Part Number	Size	Std Pk	Mstr Ctn	Disc Code	Price Each
MFL-16-1	1/16" Holes	3	0	020	222.04
MFL-32-1	1/32" Holes	3	0	020	232.14
MFL-50-1	50 Mesh	3	0	020	252.33
MFL-76-1	76 Mesh	3	0	020	358.29
MFL-100-1	100 Mesh	3	0	020	277.57
MFL-150-1	150 Mesh	3	0	020	307.85
MFL-200-1	200 Mesh	3	0	020	378.46

NOTE: When ordering replacement screens for FL and MFL Series Filters, please provide exact length of old screen within 1/64" to ensure proper fit of new screen in your filter body.

Filter Replacement Components

Part Number	Size	Std Pk	Mstr Ctn	Disc Code	Price Each
100 GPM Filter Body					
FL-11	2-1/2 1/3 X 4	1	0	020	378.46
50 GPM Filter Body					
MFL-11	2-1/2 1/3 X 2	1	0	020	290.17
Components for Old-Style Filters w/3" Bottom Cap					
Part Number	Size	Std Pk	Mstr Ctn	Disc Code	Price Each
Filter Cap w/Gasket					
FL-4A	3X1-1/4	70	0	020	31.55
FL-5A	3X1/4	70	0	020	31.55



Filters

Components for Old-Style Filters w/3" Bottom Cap

Part Number	Size	Std Pk	Mstr Ctn	Disc Code	Price Each
Cap Gasket Only					
FCG-5	3	2	0	020	10.04

Components for New-Style Filters w/4" Bottom Cap

Part Number	Size	Std Pk	Mstr Ctn	Disc Code	Price Each
Filter Cap w/O-rings					
FL-4B	4X1-1/4	25	0	020	57.97

**Components for New-Style Filters w/4" Bottom Cap
(continued)**

Part Number	Size	Std Pk	Mstr Ctn	Disc Code	Price Each
Filter Cap w/O-rings					
FL-5B	4X1/4	1	0	020	93.78
Includes Cap with Cap O-ring (1) and bottom Filter Bushing O-ring (1)					
Cap O-Ring Only					
B-242	- - -	100	0	901	.83
Filter Bushing O-Rings					
B-335-60	- - -	100	0	901	3.66
Each filter uses two (2) Filter Bushing O-rings for top and bottom screen seals					

Reverse Flow Filters



100 GPM



50 GPM

- Filter cartridge specially designed for external-to-internal filtration
- Traps sediment and debris on outside of filter (standard filters use internal-to-external flow)
- 100 GPM and 50 GPM styles available

100 GPM Reverse Flow Filter Assembly with Stainless Steel Screen

Part Number	Size	Std Pk	Mstr Ctn	Disc Code	Price Each
Socket x Socket/Spigot					
FLR-16"	4X2-1/2 /3	1	0	020	555.11
FLR-32"	4X2-1/2 /3	1	0	020	567.73
FLR-50"	4X2-1/2 /3	1	0	020	643.40
FLR-76"	4X2-1/2 /3	1	0	020	777.14
FLR-100"	4X2-1/2 /3	1	0	020	706.48
FLR-150"	4X2-1/2 /3	1	0	020	731.74
FLR-200"	4X2-1/2 /3	1	0	020	794.81

*Standard FL-16 and FL-32 can be utilized as Reverse Flow Filters by reversing installation from current inlet to outlet and current outlet to inlet.

50 GPM Filter Assembly with Stainless Steel Screen

Part Number	Size	Std Pk	Mstr Ctn	Disc Code	Price Each
Socket x Socket/Spigot					
MFLR-16"	2X2-1/2 /3	1	0	020	466.82
MFLR-32"	2X2-1/2 /3	1	0	020	474.37
MFLR-50"	2X2-1/2 /3	1	0	020	489.48
MFLR-76"	2X2-1/2 /3	1	0	020	592.98
MFLR-100"	2X2-1/2 /3	1	0	020	517.27
MFLR-150"	2X2-1/2 /3	1	0	020	542.49
MFLR-200"	2X2-1/2 /3	1	0	020	605.57

*Standard MFL-16 and MFL-32 can be utilized as Reverse Flow Filters by reversing installation from current inlet to outlet and current outlet to inlet.

**100 GPM Reverse Flow Filter Replacement Screens
(24" Length)**

Part Number	Size	Std Pk	Mstr Ctn	Disc Code	Price Each
FL-16-1	1/16" Holes	3	0	020	222.04
FL-32-1	1/32" Holes	3	0	020	242.22
FLR-50-1	50 Mesh	3	0	020	243.39
FLR-76-1	76 Mesh	3	0	020	474.37
FLR-100-1	100 Mesh	3	0	020	337.02
FLR-150-1	150 Mesh	3	0	020	383.52

**100 GPM Reverse Flow Filter Replacement Screens
(24" Length) (continued)**

Part Number	Size	Std Pk	Mstr Ctn	Disc Code	Price Each
FLR-200-1	200 Mesh	3	0	020	474.62

**50 GPM Reverse Flow Filter Replacement Screens
(12" Length)**

Part Number	Size	Std Pk	Mstr Ctn	Disc Code	Price Each
MFL-16-1	1/16" Holes	3	0	020	222.04
MFL-32-1	1/32" Holes	3	0	020	232.14
MFLR-50-1	50 Mesh	3	0	020	256.21
MFLR-76-1	76 Mesh	3	0	020	358.29
MFLR-100-1	100 Mesh	3	0	020	263.67
MFLR-150-1	150 Mesh	3	0	020	292.44
MFLR-200-1	200 Mesh	3	0	020	359.53



Schedule 40 Fittings & Accessories Reverse Flow Filters

Mesh Size	Hole Size (in.)	Part Number Extension
1/16" Holes	.0625	-16
1/32" Holes	.0312	-32
50 Mesh	.0117	-50
76 Mesh	.0095	-76
100 Mesh	.0059	-100
150 Mesh	.0041	-150
200 Mesh	.0029	-200

Additional Mesh Sizes available on request.
Example: FLR-50 = 50 Mesh

Typical Reverse Flow Application

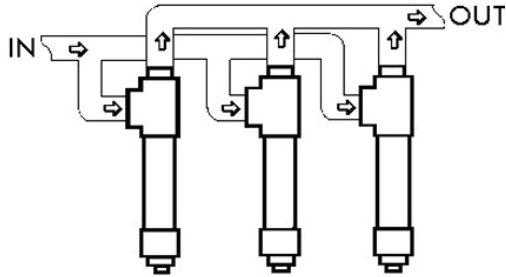

- When more than 100 gpm is required, filters may be installed in parallel
- When installing filter, allow space for removing filter screen for cleaning
- Remove stainless steel filter screen before solvent welding filter to pipe manifold
- When filters are installed in direct sunlight, it is suggested the filter body be coated with a water-base latex paint having a high reflectance
- Installation in a shaded area is preferred

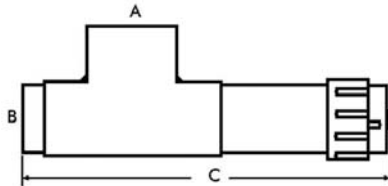

Series	A Inlet	B Outlet		C Overall Length	Screen Length	Filter Approx. Weight
		Socket	Spigot			
FLR	4	2-1/2	3	28	24	8
MFLR	4	2-1/2	3	16	12	4-3/4

Schedule 40 Fittings & Accessories
In-line Tee Style Filters and Reverse In-line Tee Style Filters



100 GPM and 50 GPM • PVC White • Buna O-ring Seal



100 GPM



50 GPM

- In-line Design Simplifies Installation.
- Allows Easy Parallel Filter Configuration for Increased Flow and Filtration.
- Removable Type 304 Stainless Steel Filter Cartridges in Assorted Perforations and Screen Mesh.
- Standard Flow Filter (Internal-to-External) Traps Sediment on Inside of Cartridge, Reverse Flow Filter (External-to-Internal) Traps Sediment on Outside of Cartridge.
- Convenient Bottom Drain with 1-1/4" NPT Stainless Steel Reinforced Plastic Thread and Plug. Optional Cap with 1/4" Outlet Available.
- 200 psi Working Pressure for Water @ 73°F (23°C).
- Manufactured from NSF® Certified PVC Material.

100 GPM PVC White Tee Filter

Part Number	Size	Std Pk	Mstr Ctn	Disc Code	Price Each
Buna-N O-ring Seal with Stainless Steel Screen					
TF-16"	2-1/2" / 3 x 2-1/2" / 3	1	0	020	555.11
TF-32"	2-1/2" / 3 x 2-1/2" / 3	1	0	020	567.73
TF-50	2-1/2" / 3 x 2-1/2" / 3	1	0	020	643.40
TF-76	2-1/2" / 3 x 2-1/2" / 3	1	0	020	777.14
TF-100	2-1/2" / 3 x 2-1/2" / 3	1	0	020	706.48
TF-150	2-1/2" / 3 x 2-1/2" / 3	1	0	020	731.74
TF-200	2-1/2" / 3 x 2-1/2" / 3	1	0	020	794.81

50 GPM PVC White Tee Filter

Part Number	Size	Std Pk	Mstr Ctn	Disc Code	Price Each
Buna-N O-ring Seal with Stainless Steel Screen					
MTF-16"	2-1/2" / 3 x 2-1/2" / 3	1	0	020	466.82
MTF-32"	2-1/2" / 3 x 2-1/2" / 3	1	0	020	474.37
MTF-50	2-1/2" / 3 x 2-1/2" / 3	1	0	020	489.48
MTF-76	2-1/2" / 3 x 2-1/2" / 3	1	0	020	592.98
MTF-100	2-1/2" / 3 x 2-1/2" / 3	1	0	020	517.27
MTF-150	2-1/2" / 3 x 2-1/2" / 3	1	0	020	542.49
MTF-200	2-1/2" / 3 x 2-1/2" / 3	1	0	020	605.57

Mesh Size	Hole Size (in.)	Part Number Extension
1/16" Holes	.0625	-16
1/32" Holes	.0312	-32
50 Mesh	.0117	-50
76 Mesh	.0095	-76
100 Mesh	.0059	-100
150 Mesh	.0041	-150
200 Mesh	.0029	-200

Additional Mesh Sizes available on request.
 Example: TF-50 = 50 Mesh

100 GPM PVC White Reverse Tee Filter

Part Number	Size	Std Pk	Mstr Ctn	Disc Code	Price Each
Buna-N O-ring Seal with Stainless Steel Screen					
TF-16"	2-1/2" / 3 x 2-1/2" / 3	1	0	020	555.11
TF-32"	2-1/2" / 3 x 2-1/2" / 3	1	0	020	567.73
TFR-50	2-1/2" / 3 x 2-1/2" / 3	1	0	020	643.40
TFR-76	2-1/2" / 3 x 2-1/2" / 3	1	0	020	777.14
TFR-100	2-1/2" / 3 x 2-1/2" / 3	1	0	020	706.48
TFR-150	2-1/2" / 3 x 2-1/2" / 3	1	0	020	731.74
TFR-200	2-1/2" / 3 x 2-1/2" / 3	1	0	020	794.81

50 GPM PVC White Reverse Tee Filter

Part Number	Size	Std Pk	Mstr Ctn	Disc Code	Price Each
Buna-N O-ring Seal with Stainless Steel Screen					
MTF-16"	2-1/2" / 3 x 2-1/2" / 3	1	0	020	466.82
MTF-32"	2-1/2" / 3 x 2-1/2" / 3	1	0	020	474.37
MTFR-50	2-1/2" / 3 x 2-1/2" / 3	1	0	020	489.48
MTFR-76	2-1/2" / 3 x 2-1/2" / 3	1	0	020	592.98
MTFR-100	2-1/2" / 3 x 2-1/2" / 3	1	0	020	517.27

50 GPM PVC White Reverse Tee Filter (continued)

Part Number	Size	Std Pk	Mstr Ctn	Disc Code	Price Each
Buna-N O-ring Seal with Stainless Steel Screen					
MTFR-150	2-1/2" / 3 x 2-1/2" / 3	1	0	020	542.49
MTFR-200	2-1/2" / 3 x 2-1/2" / 3	1	0	020	605.57

*Standard TF-16, TF-32, MTF-16 & MTF-32 can be utilized as Reverse Flow Filters by reversing installation from current inlet to outlet and current outlet to inlet.

100 GPM Filter Replacement Screens for TF Filters (24" Length)

Part Number	Size	Std Pk	Mstr Ctn	Disc Code	Price Each
FL-16-1	1/16" Holes	3	0	020	222.04
FL-32-1	1/32" Holes	3	0	020	242.22
FL-50-1	50 Mesh	3	0	020	479.42
FL-76-1	76 Mesh	3	0	020	474.37
FL-100-1	100 Mesh	3	0	020	373.45
FL-150-1	150 Mesh	3	0	020	403.71
FL-200-1	200 Mesh	3	0	020	499.60

NOTE: When ordering replacement screens for TF and MTF Series Filters, please provide exact length of old screen within 1/64" to insure proper fit of new screen in your filter body.

50 GPM Filter Replacement Screens for MTF Filters (12" Length)

Part Number	Size	Std Pk	Mstr Ctn	Disc Code	Price Each
MFL-16-1	1/16" Holes	3	0	020	222.04
MFL-32-1	1/32" Holes	3	0	020	232.14
MFL-50-1	50 Mesh	3	0	020	252.33
MFL-76-1	76 Mesh	3	0	020	358.29
MFL-100-1	100 Mesh	3	0	020	277.57
MFL-150-1	150 Mesh	3	0	020	307.85
MFL-200-1	200 Mesh	3	0	020	378.46

NOTE: When ordering replacement screens for TF and MTF Series Filters, please provide exact length of old screen within 1/64" to insure proper fit of new screen in your filter body.

100 GPM Reverse Flow Filter Replacement Screens for TFR Filters (24" Length)

Part Number	Size	Std Pk	Mstr Ctn	Disc Code	Price Each
FLR-16-1	1/16" Holes	3	0	020	222.04
FLR-32-1	1/32" Holes	3	0	020	242.22
FLR-50-1	50 Mesh	3	0	020	243.39
FLR-76-1	76 Mesh	3	0	020	474.37
FLR-100-1	100 Mesh	3	0	020	337.02
FLR-150-1	150 Mesh	3	0	020	383.52
FLR-200-1	200 Mesh	3	0	020	474.62

50 GPM Reverse Flow Filter Replacement Screens for MTFR Filters (12" Length)

Part Number	Size	Std Pk	Mstr Ctn	Disc Code	Price Each
MFL-16-1	1/16" Holes	3	0	020	222.04
MFL-32-1	1/32" Holes	3	0	020	232.14



Schedule 40 Fittings & Accessories
In-line Tee Style Filters and Reverse In-line Tee Style Filters

**50 GPM Reverse Flow Filter Replacement Screens for
MTFR Filters (12" Length) (continued)**

Part Number	Size	Std Pk	Mstr Ctn	Disc Code	Price Each
MFLR-50-1	50 Mesh	3	0	020	256.21
MFLR-76-1	76 Mesh	3	0	020	358.29
MFLR-100-1	100 Mesh	3	0	020	263.67
MFLR-150-1	150 Mesh	3	0	020	292.44
MFLR-200-1	200 Mesh	3	0	020	359.53

IN-LINE TECHNICAL INFORMATION

Dimensions

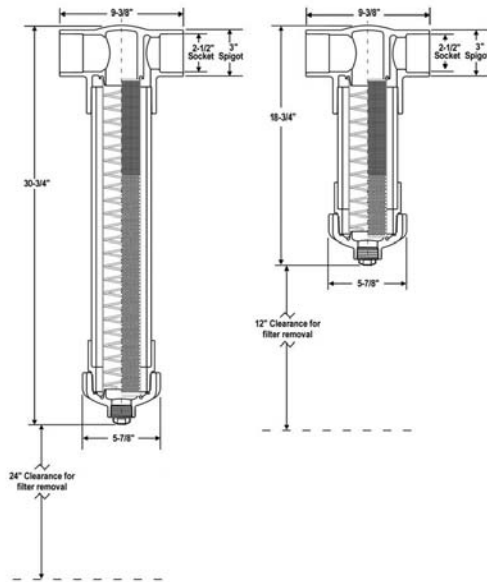

Filter includes drain plug for 1-1/4" NPT outlet. Optional valve for blow-out or filter cap with 1/4" NPT outlet can be purchased separately.

Parallel Filter Installation

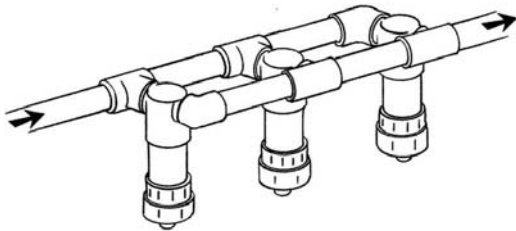

- When more than 100 gpm is required, filters may be installed in parallel.
- When installing filter, allow space for removing filter screen for cleaning.
- Remove stainless steel filter screen before solvent welding filter to pipe manifold to avoid cement contact with screen.
- When filters are installed in the direct sun, it is suggested the filter body be coated with a water-base latex paint having a high reflectance.
- Installation in a shaded area is preferred.

Pressure Loss

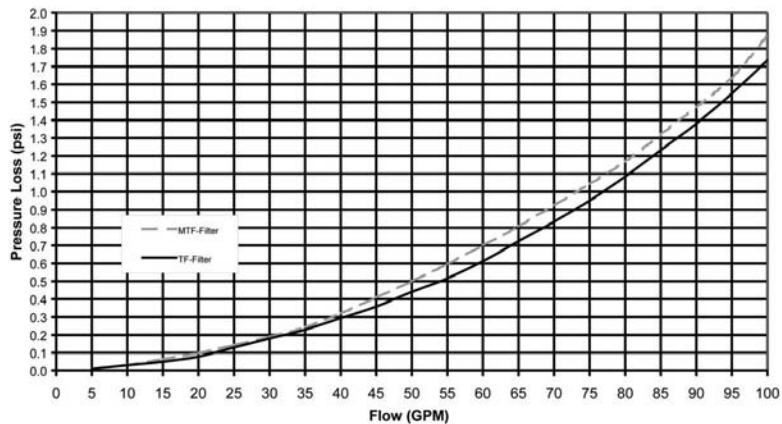



Schedule 40 Fittings & Accessories Hose Filters

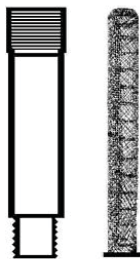

7 GPM Steel

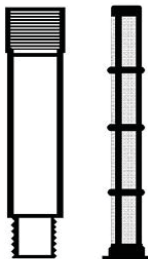

7 GPM Plastic/Nylon

NOTE: It is recommended to connect the inlet of the Hose Filter to the system with a swivel adapter such as Spears® AP Series, to facilitate servicing of the filter element (refer to Hose Fittings).

Mesh Size	Hole Size (in.)	Part Number Extension
20 Mesh	.0331	-20
30 Mesh	.0232	-30
50 Mesh	.0117	-50
80 Mesh	.0070	-80
100 Mesh	.0059	-100
150 Mesh	.0041	-150
200 Mesh	.0029	-200

Additional Mesh Sizes available on request.
Example: HF-50 = 50 Mesh

7 GPM Hose Filter Assembly

Part Number	Size	Std Pk	Mstr Ctn	Disc Code	Price Each
-------------	------	--------	----------	-----------	------------

with Stainless Steel Screen

HF-20	3/4	10	60	020	18.71
HF-30	3/4	10	60	020	18.71
HF-50	3/4	10	60	020	18.71
HF-80	3/4	10	60	020	18.71
HF-100	3/4	10	60	020	19.43
HF-150	3/4	10	60	020	19.67
HF-200	3/4	10	60	020	20.20

with Plastic/Nylon Screen

HF-150N	3/4	10	60	020	19.67
---------	-----	----	----	-----	-------

Hose Filter Replacement Screen

Part Number	Size	Std Pk	Mstr Ctn	Disc Code	Price Each
-------------	------	--------	----------	-----------	------------

Stainless Steel Screen

HF-20-1W	5	25	150	020	6.84
HF-30-1W	5	25	150	020	6.84
HF-50-1W	5	25	150	020	6.84
HF-80-1W	5	25	150	020	6.84
HF-100-1W	5	25	150	020	10.11
HF-150-1W	5	25	150	020	10.11
HF-200-1W	5	25	150	020	10.11

Plastic/Nylon Screen

HF-150-1NW	4-3/4	25	150	020	10.11
------------	-------	----	-----	-----	-------

7 GPM Hose Filter Body Components

Part Number	Size	Std Pk	Mstr Ctn	Disc Code	Price Each
-------------	------	--------	----------	-----------	------------

Hose Filter Body w/o screen

HF	3/4	10	60	020	14.07
----	-----	----	----	-----	-------

Hose Washer

W-100	3/4	50	1500	020	.04
-------	-----	----	------	-----	-----

Screen Washer

S-W	- - -	600	0	901	.21
-----	-------	-----	---	-----	-----