

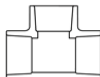

Schedule 80 CPVC Industrial Products & Accessories
CPVC Schedule 80 Fittings

Part Number	Size	Std Pk	Mstr Ctn	Disc Code	Price Each
-------------	------	--------	----------	-----------	------------

Tee Soc



801-002C	1/4	50	300	090	14.16
801-003C	3/8	25	150	090	14.16
801-005C	1/2	25	200	090	14.16
801-007C	3/4	15	120	090	14.41
801-010C	1	15	0	090	17.66
801-012C	1-1/4	10	0	090	37.25
801-015C	1-1/2	10	0	090	42.67
801-020C	2	10	0	090	47.49
801-025C	2-1/2	10	0	090	120.91
801-030C	3	5	0	090	120.91
801-040C	4	5	0	090	160.91
801-050C	5	5	0	090	397.78
801-060C	6	2	0	090	418.74
801-080C	8	2	0	090	1199.48
801-100C	10	1	0	091	2372.94
801-100CF	10	1	0	097	1764.54
801-120C	12	1	0	091	3667.31
801-120CF	12	1	0	097	2408.22
801-140CF	14	1	0	097	6291.51
801-160CF	16	1	0	097	8987.85
801-180CF	18	1	0	097	10535.60
801-200CF	20	1	0	097	15941.67
801-240CF	24	1	0	097	22376.02

Tee Soc x Fipt

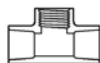

802-002C	1/4	25	150	090	35.94
802-005C	1/2	20	120	090	35.94
802-007C	3/4	20	160	090	47.93
802-010C	1	15	0	090	59.91
802-012C	1-1/4	15	0	090	70.41
802-015C	1-1/2	10	0	090	70.41
802-020C	2	10	0	090	88.43
802-030C	3	5	0	090	105.39
802-040C	4	5	0	090	198.01
802-060CF	6	1	2	097	405.25

Special Reinforced Tee Soc x SR Fipt - Stainless Steel Collar

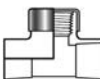

802-005CSR	1/2	50	0	096	19.67
802-007CSR	3/4	15	120	096	28.75
802-010CSR	1	15	0	096	36.17
802-012CSR	1-1/4	15	0	096	41.96
802-015CSR	1-1/2	10	0	096	41.96
802-020CSR	2	10	0	096	68.59
802-030CSR	3	5	0	096	98.78
802-040CSR	4	5	0	096	186.09

Transition Tee Soc x Fipt With Brass Thread Insert



802-005CBR	1/2	20	160	096	58.38
802-007CBR	3/4	25	0	096	116.75

Not intended to convey or dispense water for human consumption through drinking or cooking

Tee Fipt

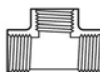

805-002C	1/4	25	150	090	31.46
805-003C	3/8	25	150	090	31.46

Part Number	Size	Std Pk	Mstr Ctn	Disc Code	Price Each
-------------	------	--------	----------	-----------	------------

Tee (continued) Fipt

805-005C	1/2	20	120	090	31.46
805-007C	3/4	15	120	090	45.32
805-010C	1	15	0	090	48.81
805-012C	1-1/4	10	0	090	49.09
805-015C	1-1/2	10	0	090	51.55
805-020C	2	10	0	090	57.26
805-025C	2-1/2	5	0	090	281.52
805-030C	3	5	0	090	326.63
805-040C	4	5	0	090	773.80

Special Reinforced Tee SR Fipt - Stainless Steel Collar

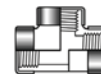

805-002CSR	1/4	20	160	096	17.60
805-003CSR	3/8	25	150	096	17.60
805-005CSR	1/2	25	150	096	23.55
805-007CSR	3/4	25	100	096	26.98
805-010CSR	1	15	0	096	40.29
805-015CSR	1-1/2	10	0	096	42.78
805-020CSR	2	10	0	096	50.94

Street Tee Spig x Soc x Soc



844-005C	1/2	25	200	090	17.72
844-007C	3/4	15	120	090	18.02
844-010C	1	15	0	090	22.08
844-012C	1-1/4	10	0	090	46.55
844-015C	1-1/2	10	0	090	53.36
844-020C	2	10	0	090	59.40

Reducing Tee Soc



801-101C	3/4X1/2	15	120	090	31.59
801-130C	1X1/2	15	0	090	36.41
801-131C	1X3/4	15	0	090	36.41
801-158C	1-1/4X1X1	15	0	090	45.16
801-159C	1-1/4X1X1-1/4	15	0	090	45.16
801-166C ¹	1-1/4X1/2	10	0	090	83.49
801-167C	1-1/4X3/4	12	0	090	71.25
801-168C	1-1/4X1	15	0	090	71.25
801-202C	1-1/2X1-1/4X1	10	0	090	71.25
801-209C	1-1/2X1/2	10	0	090	74.42
801-210C	1-1/2X3/4	15	0	090	74.42
801-211C	1-1/2X1	10	0	090	74.42
801-212C	1-1/2X1-1/4	10	0	090	74.42
801-247C	2X1/2	10	0	090	88.65
801-248C	2X3/4	10	0	090	88.65
801-249C	2X1	10	0	090	88.65
801-250C ¹	2X1-1/4	10	0	090	122.83
801-251C	2X1-1/2	10	0	090	88.65
801-287C	2-1/2X1/2	10	0	090	101.80
801-288C	2-1/2X3/4	10	0	090	101.80
801-289C	2-1/2X1	10	0	090	101.80
801-290C	2-1/2X1-1/4	10	0	090	101.80
801-291C	2-1/2X1-1/2	10	0	090	101.80
801-292C	2-1/2X2	10	0	090	105.37
801-333C ¹	3X1/2	5	0	090	224.08
801-334C ¹	3X3/4	5	0	090	224.08
801-335C	3X3X1	5	0	090	180.88
801-336C ¹	3X1-1/4	5	0	090	216.95
801-337C	3X3X1-1/2	5	0	090	180.88
801-338C	3X2	5	0	090	180.88
801-339C	3X2-1/2	6	0	090	180.88

Schedule 80 CPVC Industrial Products & Accessories
CPVC Schedule 80 Fittings



Part Number	Size	Std Pk	Mstr Ctn	Disc Code	Price Each
-------------	------	--------	----------	-----------	------------

Reducing Tee (continued)

Soc

801-415C ¹	4X1/2	5	0	090	275.08
801-416C ¹	4X3/4	5	0	090	275.08
801-417C ¹	4X1	4	0	090	275.08
801-418C ¹	4X1-1/4	5	0	090	275.08
801-419C	4X1-1/2	5	0	090	275.08
801-420C	4X2	5	0	090	228.62
801-421C ¹	4X2-1/2	5	0	090	307.64
801-422C	4X3	5	0	090	228.62
801-426C ¹	4X6	4	0	090	792.52
801-525C	6X1	4	0	090	786.36
801-525CF	6X1	1	3	097	357.62
801-526C ¹	6X1-1/4	4	0	090	786.36
801-526CF	6X1-1/4	1	3	097	435.61
801-527C ¹	6X1-1/2	4	0	090	786.36
801-527CF	6X1-1/2	1	4	097	407.57
801-528C ¹	6X2	4	0	090	730.62
801-528CF	6X2	1	3	097	427.16
801-529C ¹	6X2-1/2	4	0	090	806.60
801-529CF	6X2-1/2	1	3	097	445.66
801-530C ¹	6X3	4	0	090	730.62
801-530CF	6X3	1	3	097	467.13
801-532C	6X4	5	0	090	645.69
801-575CF	8X1	1	2	097	501.51
801-576CF	8X1-1/4	1	0	097	509.48
801-577CF	8X1-1/2	1	0	097	513.26
801-578C ¹	8X2	2	0	090	1365.04
801-578CF	8X2	1	2	097	570.99
801-579CF	8X2-1/2	1	2	097	620.56
801-580C ¹	8X3	2	0	090	1365.04
801-580CF	8X3	1	2	097	700.25
801-582C ¹	8X4	2	0	090	1365.04
801-582CF	8X4	1	2	097	753.47
801-585C	8X6	2	0	090	1185.29
801-618CF	10X1	1	0	097	781.60
801-619CF	10X1-1/4	1	0	097	792.82
801-620CF	10X1-1/2	1	0	097	829.38
801-621C ¹	10X2	1	0	091	2389.55
801-621CF	10X2	1	0	097	788.14
801-622CF	10X2-1/2	1	0	097	977.49
801-623C ¹	10X3	1	0	091	2267.66
801-623CF	10X3	1	0	097	1062.07
801-624C ¹	10X4	1	0	091	2267.66
801-624CF	10X4	1	0	097	1122.64
801-626C	10X6	1	0	091	2088.20
801-626CF	10X6	1	0	097	1230.57
801-628C ¹	10X8	1	0	091	3416.27
801-628CF	10X8	1	0	097	1427.35
801-661CF	12X2	1	0	097	1337.52
801-662CF	12X2-1/2	0	0	097	1402.63
801-663CF	12X3	1	0	097	1475.21
801-664C ¹	12X4	1	0	091	4113.36
801-664CF	12X4	1	0	097	1536.16
801-666C ¹	12X6	1	0	091	3852.78
801-666CF	12X6	1	0	097	1666.85
801-668C	12X8	1	0	091	3262.88
801-668CF	12X8	1	0	097	1866.06
801-670C ¹	12X10	1	0	091	4979.23
801-670CF	12X10	1	0	097	2153.63
801-691CF	14X2	1	0	097	2763.20
801-692CF	14X2-1/2	1	0	097	2771.35
801-693CF	14X3	1	0	097	3981.56
801-694CF	14X4	1	0	097	4126.61
801-696CF	14X6	1	0	097	4494.16
801-698CF	14X8	1	0	097	4848.62
801-700CF	14X10	1	0	097	5303.43

Part Number	Size	Std Pk	Mstr Ctn	Disc Code	Price Each
-------------	------	--------	----------	-----------	------------

Reducing Tee (continued)

Soc

801-702CF	14X12	1	0	097	5830.46
801-751CF	16X2	1	0	097	3917.61
801-752CF	16X2-1/2	1	0	097	3973.69
801-753CF	16X3	1	0	097	4083.53
801-754CF	16X4	1	0	097	4235.22
801-756CF	16X6	1	0	097	5515.57
801-758CF	16X8	1	0	097	6165.58
801-760CF	16X10	1	0	097	6673.76
801-762CF	16X12	1	0	097	7464.55
801-764CF	16X14	1	0	097	8293.18
801-781CF	18X2	1	0	097	5325.66
801-783CF	18X3	1	0	097	5516.85
801-784CF	18X4	1	0	098	5320.01
801-786CF	18X6	1	0	097	7198.72
801-788CF	18X8	1	0	097	7729.63
801-790CF	18X10	1	0	097	8307.51
801-792CF	18X12	1	0	097	8883.53
801-794CF	18X14	1	0	097	9375.15
801-796CF	18X16	1	0	097	9898.45
801-814CF	20X4	1	0	097	10953.03
801-816CF	20X6	1	0	097	13033.84
801-818CF	20X8	1	0	097	13457.20
801-820CF	20X10	1	0	097	14627.86
801-822CF	20X12	1	0	097	15337.88
801-824CF	20X14	1	0	097	17087.84
801-826CF	20X16	1	0	097	18458.91
801-828CF	20X18	1	0	097	19610.53
801-904CF	24X4	1	0	097	13573.93
801-906CF	24X6	1	0	097	14639.59
801-908CF	24X8	1	0	097	14988.65
801-910CF	24X10	1	0	097	15797.55
801-912CF	24X12	1	0	097	16604.60
801-914CF	24X14	1	0	097	18044.21
801-916CF	24X16	1	0	097	21191.27
801-918CF	24X18	1	0	097	23557.84
801-920CF	24X20	1	0	097	26163.93

¹ Sized with Bushing

Reducing Tee
Soc x Fipt



802-101C	3/4X1/2	15	60	090	22.28
802-130C	1X1/2	50	0	090	44.73
802-131C	1X3/4	15	0	090	44.73
802-166C	1-1/4X1/2	25	0	090	77.08
802-167C ¹	1-1/4X3/4	15	0	090	77.08
802-168C	1-1/4X1	10	0	090	77.08
802-209C ¹	1-1/2X1/2	25	0	090	113.98
802-210C ¹	1-1/2X3/4	20	0	090	113.98
802-211C ¹	1-1/2X1	10	0	090	113.98
802-212C	1-1/2X1-1/4	10	0	090	113.98
802-247C	2X1/2	10	0	090	143.03
802-248C	2X3/4	10	0	090	143.03
802-249C ¹	2X1	10	0	090	143.03
802-250C ¹	2X1-1/4	10	0	090	143.03
802-251C ¹	2X1-1/2	10	0	090	143.03
802-287C	2-1/2X1/2	10	0	090	187.88
802-288C ¹	2-1/2X3/4	10	0	090	187.88
802-289C ¹	2-1/2X1	10	0	090	187.88
802-290C ¹	2-1/2X1-1/4	10	0	090	187.88
802-291C ¹	2-1/2X1-1/2	10	0	090	187.88
802-292C ¹	2-1/2X2	10	0	090	207.39
802-333C ¹	3X1/2	5	0	090	317.84



Schedule 80 CPVC Industrial Products & Accessories
CPVC Schedule 80 Fittings

Part Number	Size	Std Pk	Mstr Ctn	Disc Code	Price Each
-------------	------	--------	----------	-----------	------------

Reducing Tee (continued)

Soc x Fipt

802-334C ¹	3X3/4	5	0	090	317.84
802-335C ¹	3X1	5	0	090	317.84
802-336C ¹	3X1-1/4	5	0	090	317.84
802-337C ¹	3X1-1/2	5	0	090	317.84
802-338C ¹	3X2	5	0	090	317.84
802-339C ¹	3X2-1/2	5	0	090	317.84
802-415C ¹	4X1/2	5	0	090	532.29
802-416C ¹	4X3/4	5	0	090	532.29
802-417C ¹	4X1	5	0	090	532.29
802-418C ¹	4X1-1/4	5	0	090	532.29
802-419C ¹	4X1-1/2	5	0	090	532.29
802-420C ¹	4X2	5	0	090	532.29
802-421C ¹	4X2-1/2	5	0	090	532.29
802-422C ¹	4X3	5	0	090	532.29
802-525C ¹	6X1	4	0	090	1037.86
802-526C	6X1-1/4	4	0	090	1037.86
802-527C	6X1-1/2	4	0	090	1037.86
802-528C ¹	6X2	4	0	090	1037.86
802-529C ¹	6X2-1/2	4	0	090	1037.86
802-530C ¹	6X3	4	0	090	1037.86
802-532C ¹	6X4	2	0	090	1191.34
802-578C ¹	8X2	2	0	090	1973.55
802-580C ¹	8X3	2	0	090	1973.55
802-582C ¹	8X4	2	0	090	1973.55
802-621C ¹	10X2	1	0	091	2894.89
802-623C ¹	10X3	1	0	091	2894.89
802-624C ¹	10X4	1	0	091	2894.89
802-661C ¹	12X2	2	0	091	4803.17
802-663C ¹	12X3	2	0	091	4803.17
802-664C ¹	12X4	1	0	091	4803.17

¹ Sized with Bushing

Reducing Tee

Soc x Fipt x Soc



803-095C	3/4X1/2X3/4	50	0	090	19.94
----------	-------------	----	---	-----	-------

Special Reinforced Reducing Tee

Soc x SR Fipt - Stainless Steel Collar



802-072CSR	1/2X1/4	25	200	096	19.67
802-098CSR	3/4X1/4	25	100	096	26.29
802-101CSR	3/4X1/2	50	0	096	26.29
802-128CSR ¹	1X1/4	15	0	096	40.60
802-130CSR	1X1/2	50	0	096	16.06
802-131CSR	1X3/4	15	0	096	40.60
802-164CSR ¹	1-1/4X1/4	5	0	096	53.99
802-166CSR	1-1/4X1/2	15	0	096	42.77
802-168CSR	1-1/4X1	10	0	096	43.64
802-207CSR ¹	1-1/2X1/4	15	0	096	77.31
802-211CSR	1-1/2X1	10	0	096	51.24
802-212CSR	1-1/2X1-1/4	10	0	096	51.24
802-245CSR ¹	2X1/4	10	0	096	88.80
802-247CSR	2X1/2	10	0	096	79.93
802-248CSR	2X3/4	10	0	096	88.80
802-287CSR	2-1/2X1/2	10	0	096	61.07
802-331CSR ¹	3X1/4	5	0	096	169.62
802-413CSR ¹	4X1/4	5	0	096	184.06

¹ Sized with Bushing

Special Reinforced Reducing Tee

Soc x SR Fipt - Stainless Steel Collar x Soc



(See also Gauge & Instrument Fittings for additional configurations)

803-095CSR	3/4X1/2X3/4	15	0	096	16.20
------------	-------------	----	---	-----	-------

Part Number	Size	Std Pk	Mstr Ctn	Disc Code	Price Each
-------------	------	--------	----------	-----------	------------

Transition Reducing Tee

Soc x Fipt With Brass Thread Insert

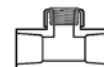

802-101CBR	3/4X1/2	50	0	096	72.36
------------	---------	----	---	-----	-------

Not intended to convey or dispense water for human consumption through drinking or cooking

90° EII

Soc



806-002C	1/4	25	150	090	15.41
806-003C	3/8	20	120	090	15.41
806-005C	1/2	20	240	090	6.04
806-007C	3/4	20	160	090	7.71
806-010C	1	25	0	090	12.24
806-012C	1-1/4	10	0	090	26.48
806-015C	1-1/2	10	0	090	29.54
806-020C	2	25	0	090	35.65
806-025C	2-1/2	5	0	090	82.11
806-030C	3	5	0	090	92.97
806-040C	4	5	0	090	167.44
806-050C	5	4	0	090	319.64
806-050CF	5	1	4	097	420.87
806-060C	6	4	0	090	336.46
806-080C	8	2	0	090	823.36
806-080CF	8	1	2	097	597.17
806-100C	10	1	0	091	2200.33
806-100CF	10	1	0	097	1308.26
806-120C	12	1	0	091	2977.04
806-120CF	12	1	0	097	2408.47
806-140CF	14	1	0	097	5991.56
806-160CF	16	1	0	097	8179.48
806-180CF	18	1	0	097	10246.01
806-200CF	20	1	0	097	11778.03
806-240CF	24	1	0	097	21320.83

Sweep 90° EII

Soc



806-005SC	1/2	25	150	090	11.88
806-007SC	3/4	25	100	090	15.32
806-010SC	1	25	0	090	24.61
806-012SC	1-1/4	25	0	090	32.52
806-015SC	1-1/2	25	0	090	34.93
806-020SC	2	25	0	090	42.32

Long Sweep 90° EII

Soc



806-005LSCF	1/2	25	0	097	54.77
806-007LSCF	3/4	25	0	097	61.35
806-010LSCF	1	25	0	097	69.37
806-012LSCF	1-1/4	25	0	097	72.68
806-015LSCF	1-1/2	25	0	097	81.15
806-020LSCF	2	10	0	097	113.84
806-030LSCF	3	1	5	097	157.94
806-040LSCF	4	1	4	097	195.38
806-060LSCF	6	1	2	097	288.13

Not Listed for Electrical Conduit Use

90° EII

Soc x Fipt

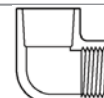

807-002C	1/4	25	450	090	13.65
807-003C	3/8	25	150	090	13.65
807-005C	1/2	20	120	090	15.94

Schedule 80 CPVC Industrial Products & Accessories
CPVC Schedule 80 Fittings



Part Number	Size	Std Pk	Mstr Ctn	Disc Code	Price Each
90° EII (continued)					
Soc x Fipt					
807-007C	3/4	20	160	090	18.72
807-010C	1	20	0	090	24.51
807-012C	1-1/4	10	0	090	35.94
807-015C	1-1/2	10	0	090	54.44
807-020C	2	10	0	090	69.88
807-030C	3	5	0	090	84.23
807-040C	4	5	0	090	159.28

Special Reinforced 90° EII
Soc x SR Fipt - Stainless Steel Collar

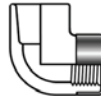

807-005CSR	1/2	20	240	096	9.55
807-007CSR	3/4	75	0	096	11.22
807-010CSR	1	50	0	096	13.51
807-015CSR	1-1/2	10	0	096	33.53
807-020CSR	2	10	0	096	41.95
807-030CSR	3	5	0	096	61.06
807-040CSR	4	5	0	096	112.74

Transition 90° EII
Soc x Fipt With Brass Thread Insert

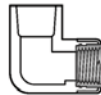

807-005CBR	1/2	20	240	096	51.33
807-007CBR	3/4	20	160	096	89.61

Not intended to convey or dispense water for human consumption through drinking or cooking

90° EII
Fipt

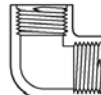

808-002C	1/4	25	450	090	16.19
808-003C	3/8	25	150	090	16.19
808-005C	1/2	20	120	090	9.40
808-007C	3/4	20	120	090	14.05
808-010C	1	15	120	090	19.73
808-012C	1-1/4	10	0	090	38.00
808-015C	1-1/2	10	0	090	40.89
808-020C	2	10	0	090	54.81
808-025C	2-1/2	5	0	090	170.09
808-030C	3	5	0	090	182.39
808-040C	4	5	0	090	285.41

90° Street EII
Mipt x Fipt



812-002C	1/4	50	300	090	23.06
----------	-----	----	-----	-----	-------

Special Reinforced 90° EII
SR Fipt - Stainless Steel Collar

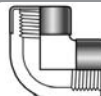

808-003CSR	3/8	25	150	096	5.77
808-005CSR	1/2	20	120	096	5.77
808-007CSR	3/4	20	160	096	8.45
808-010CSR	1	50	0	096	10.83
808-012CSR	1-1/4	25	0	096	20.84
808-015CSR	1-1/2	10	0	096	24.54
808-020CSR	2	10	0	096	32.87

90° Street EII
Spig x Soc



809-005C	1/2	50	200	090	7.58
809-007C	3/4	50	0	090	9.64
809-010C	1	50	0	090	15.32

Part Number	Size	Std Pk	Mstr Ctn	Disc Code	Price Each
90° Street EII (continued)					
Spig x Soc					
809-012C	1-1/4	25	0	090	33.12
809-015C	1-1/2	10	0	090	36.96
809-020C	2	25	0	090	44.62
809-025C	2-1/2	5	0	090	90.06
809-030C	3	5	0	090	123.98
809-040C	4	4	0	090	223.26
809-060C	6	2	0	090	448.62
809-080C	8	2	0	090	1097.82
809-100C	10	1	0	091	2933.45
809-120C	12	1	0	091	3967.85

Reducing 90° EII
Soc x Fipt

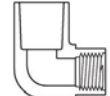

807-101C	3/4X1/2	10	60	090	15.29
807-130C ¹	1X1/2	10	80	090	21.85
807-131C ¹	1X3/4	10	80	090	21.85

¹ Sized with Bushing

Special Reinforced Reducing 90° EII
Soc x SR Fipt - Stainless Steel Collar

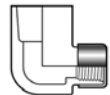

807-101CSR	3/4X1/2	50	0	096	12.17
807-130CSR	1X1/2	50	0	096	13.12

Transition Reducing 90° EII
Soc x Fipt With Brass Thread Insert

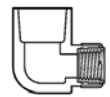

807-101CBR	3/4X1/2	20	120	096	64.19
------------	---------	----	-----	-----	-------

Not intended to convey or dispense water for human consumption through drinking or cooking

60° EII
Soc



824-005CF	1/2	1	25	097	93.12
824-007CF	3/4	1	6	097	111.20
824-010CF	1	1	15	097	105.31
824-012CF	1-1/4	1	16	097	107.84
824-015CF	1-1/2	1	15	097	116.77
824-020CF	2	1	16	097	147.07
824-025CF	2-1/2	1	10	097	168.32
824-030CF	3	1	4	097	288.79
824-040CF	4	1	4	097	346.66
824-060CF	6	1	4	097	481.09
824-080CF	8	1	0	097	728.94
824-100CF	10	1	0	097	1467.44
824-120CF	12	1	0	097	2268.25
824-140CF	14	1	0	097	5468.05
824-160CF	16	1	0	097	7676.98
824-180CF	18	1	0	097	10650.42

45° EII
Soc

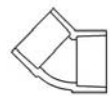

817-002C	1/4	25	450	090	22.92
817-003C	3/8	25	150	090	22.92
817-005C	1/2	20	120	090	7.39
817-007C	3/4	20	120	090	10.67
817-010C	1	15	120	090	16.97
817-012C	1-1/4	10	80	090	33.33
817-015C	1-1/2	10	0	090	34.22
817-020C	2	10	0	090	38.38
817-025C	2-1/2	5	0	090	78.43
817-030C	3	5	0	090	100.78



Schedule 80 CPVC Industrial Products & Accessories
CPVC Schedule 80 Fittings

Part Number	Size	Std Pk	Mstr Ctn	Disc Code	Price Each
-------------	------	--------	----------	-----------	------------

45° EII (continued)

Soc

817-040C	4	5	0	090	138.35
817-050C	5	4	0	090	404.88
817-060C	6	4	0	090	426.20
817-080C	8	2	0	090	886.72
817-100C	10	1	0	091	1682.66
817-100CF	10	1	2	097	1016.13
817-120C	12	1	0	091	2960.35
817-120CF	12	1	0	097	1426.75
817-140CF	14	1	0	097	2984.57
817-160CF	16	1	0	097	4356.18
817-180CF	18	1	0	097	6741.28
817-200CF	20	1	0	097	8918.20
817-240CF	24	1	0	097	10755.98

45° EII

Fipt



819-002C	1/4	25	450	090	21.54
819-003C	3/8	25	150	090	21.54
819-005C	1/2	20	240	090	20.40
819-007C	3/4	10	60	090	22.41
819-010C	1	10	120	090	24.66
819-012C	1-1/4	10	80	090	42.13
819-015C	1-1/2	10	0	090	42.13
819-020C	2	10	0	090	55.62
819-025C	2-1/2	5	0	090	105.44
819-030C	3	5	0	090	151.87
819-040C	4	5	0	090	238.88

Special Reinforced 45° EII

SR Fipt - Stainless Steel Collar



819-007CSR	3/4	10	120	096	13.19
------------	-----	----	-----	-----	-------

45° Street EII

Spig x Soc



827-005C	1/2	50	400	090	7.39
827-007C	3/4	50	0	090	10.67
827-010C	1	50	0	090	16.97
827-012C	1-1/4	25	0	090	33.33
827-015C	1-1/2	25	0	090	34.17
827-020C	2	10	0	090	38.38
827-025C	2-1/2	12	0	090	84.94
827-030C	3	10	0	090	100.78
827-040C	4	5	0	090	138.35
827-060C	6	3	0	090	501.41
827-080C	8	2	0	090	1043.18
827-100C	10	1	0	091	1979.60
827-120C	12	1	0	091	3482.75
827-140CF	14	1	0	097	4266.85
827-160CF	16	1	0	097	5457.93
827-180CF	18	1	0	097	7963.73

30° EII

Soc

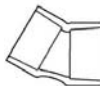

815-005CF	1/2	1	25	097	32.47
815-007CF	3/4	1	25	097	33.47
815-010CF	1	1	20	097	46.29
815-012CF	1-1/4	1	15	097	49.37
815-015CF	1-1/2	1	25	097	53.23
815-020CF	2	25	0	097	100.06
815-025CF	2-1/2	1	18	097	111.81

Part Number	Size	Std Pk	Mstr Ctn	Disc Code	Price Each
-------------	------	--------	----------	-----------	------------

30° EII (continued)

Soc

815-030CF	3	1	10	097	124.71
815-040CF	4	1	18	097	162.85
815-060C	6	5	0	090	501.41
815-080CF	8	1	3	097	593.97
815-100CF	10	1	2	097	985.97
815-120CF	12	1	2	097	1298.61
815-140CF	14	1	0	097	2757.37
815-160CF	16	1	0	097	3881.69
815-180CF	18	1	0	097	5627.37

22-1/2° EII

Soc



816-005C	1/2	20	240	090	8.71
816-007C	3/4	20	240	090	12.54
816-010C	1	20	160	090	19.97
816-012C	1-1/4	20	0	090	39.19
816-015C	1-1/2	20	0	090	40.27
816-020C	2	20	0	090	45.16
816-025C	2-1/2	5	0	090	113.34
816-025CF	2-1/2	1	18	097	111.81
816-030C	3	5	0	090	118.57
816-040C	4	4	0	090	162.76
816-060C	6	4	0	090	501.41
816-060CF	6	1	8	097	312.57
816-080C	8	4	0	090	1043.18
816-080CF	8	1	4	097	593.97
816-100CF	10	1	2	097	985.97
816-120CF	12	1	2	097	1298.61
816-140CF	14	1	0	097	2757.37
816-160CF	16	1	0	097	3881.69
816-180CF	18	1	0	097	5627.37

22-1/2° Street EII

Spig x Soc



842-005C	1/2	50	400	090	9.91
842-007C	3/4	50	0	090	15.46
842-010C	1	50	0	090	24.19
842-012C	1-1/4	20	0	090	30.29
842-015C	1-1/2	25	0	090	43.55
842-020C	2	20	0	090	54.92
842-025C	2-1/2	5	0	090	100.83
842-030C	3	5	0	090	146.44
842-040C	4	4	0	090	187.79
842-060C	6	1	6	090	619.23
842-080C	8	1	2	090	1298.25
842-100CF	10	1	2	097	1001.75
842-120CF	12	1	2	097	1328.65

15° EII

Soc



818-005CF	1/2	1	25	097	32.47
818-007CF	3/4	1	23	097	33.47
818-010CF	1	1	20	097	46.29
818-012CF	1-1/4	1	15	097	49.37
818-015CF	1-1/2	1	25	097	53.23
818-020CF	2	1	25	097	100.06
818-025CF	2-1/2	1	18	097	111.81
818-030CF	3	1	35	097	124.71
818-040CF	4	1	18	097	162.85
818-060CF	6	1	8	097	312.57
818-080CF	8	1	3	097	593.97
818-100CF	10	1	2	097	985.97

Schedule 80 CPVC Industrial Products & Accessories
CPVC Schedule 80 Fittings



Part Number	Size	Std Pk	Mstr Ctn	Disc Code	Price Each
-------------	------	--------	----------	-----------	------------

15° Ell (continued)

Soc

818-120CF	12	1	0	097	1298.61
818-140CF	14	1	0	097	2757.37
818-160CF	16	1	0	097	3881.69
818-180CF	18	1	0	097	5627.37

11-1/4° Ell

Soc

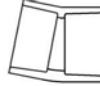

811-005CF	1/2	1	52	097	32.47
811-007CF	3/4	1	20	097	33.47
811-010CF	1	1	50	097	46.29
811-012CF	1-1/4	1	26	097	49.37
811-015C	1-1/2	25	0	090	36.92
811-020C	2	10	0	090	45.16
811-025CF	2-1/2	1	25	097	111.81
811-030C	3	10	0	090	118.57
811-040C	4	4	0	090	162.76
811-060CF	6	1	5	097	312.57
811-080CF	8	1	3	097	593.97
811-100CF	10	1	2	097	985.97
811-120CF	12	1	2	097	1298.61
811-140CF	14	1	0	097	2757.37
811-160CF	16	1	0	097	3881.69
811-180CF	18	1	0	097	5627.37

Wye

Soc



1/2" - 2" - 235 psi Maximum Internal Pressure Rating @ 73°F (23°C)
2-1/2" - 6" - 150 psi Maximum Internal Pressure Rating @ 73°F (23°C)
8" - Larger & All Fabricated Sizes - 100 psi Maximum Internal Pressure Rating @ 73°F (23°C)

875-005C	1/2	25	100	090	16.41
875-007C	3/4	25	0	090	16.95
875-010C	1	20	0	090	28.56
875-012C	1-1/4	20	0	090	43.25
875-015C	1-1/2	20	0	090	46.49
875-020C	2	10	0	090	113.85
875-025C ¹	2-1/2	4	0	090	802.56
875-030C	3	5	0	090	561.37
875-040C	4	4	0	090	593.51
875-060C	6	3	0	090	812.32
875-080C	8	1	0	090	1387.25
875-080CF [*]	8	1	0	097	1213.35
875-100CF [*]	10	1	0	097	2084.38
875-120CF [*]	12	1	0	097	2903.25
875-140CF [*]	14	1	0	097	10093.83
875-160CF [*]	16	1	0	097	12660.95
875-180CF [*]	18	1	0	097	18372.52

¹ Sized with Bushing

* An asterisk (*) appearing after a fabricated fitting part number indicates the item is fiberglass reinforced.

Reducing Wye

Soc



1/2" - 2" - 235 psi Maximum Internal Pressure Rating @ 73°F (23°C)
3" - 6" - 150 psi Maximum Internal Pressure Rating @ 73°F (23°C)
8" - Larger & All Fabricated Sizes - 100 psi Maximum Internal Pressure Rating @ 73°F (23°C)

875-101C ¹	3/4X1/2	25	0	090	24.23
875-130C ¹	1X1/2	20	0	090	39.93
875-131C ¹	1X3/4	20	0	090	39.93
875-166C ¹	1-1/4X1/2	20	0	090	72.78

Part Number	Size	Std Pk	Mstr Ctn	Disc Code	Price Each
-------------	------	--------	----------	-----------	------------

Reducing Wye (continued)

Soc

875-167C ¹	1-1/4X3/4	20	0	090	72.78
875-168C ¹	1-1/4X1	20	0	090	72.78
875-209C ¹	1-1/2X1/2	20	0	090	79.83
875-210C ¹	1-1/2X3/4	20	0	090	79.83
875-211C ¹	1-1/2X1	20	0	090	79.83
875-212C ¹	1-1/2X1-1/4	20	0	090	79.83
875-247C ¹	2X1/2	10	0	090	157.96
875-248C ¹	2X3/4	10	0	090	157.96
875-249C ¹	2X1	10	0	090	157.96
875-250C ¹	2X1-1/4	10	0	090	157.96
875-251C ¹	2X1-1/2	10	0	090	157.96
875-335C ¹	3X1	5	0	090	649.75
875-336C ¹	3X1-1/4	5	0	090	649.75
875-337C ¹	3X1-1/2	5	0	090	649.75
875-338C ¹	3X2	4	0	090	649.75
875-339C ¹	3X2-1/2	5	0	090	649.75
875-420C	4X2	4	0	090	657.03
875-422C ¹	4X3	4	0	090	657.03
875-528C ¹	6X2	5	0	090	832.20
875-528CF [*]	6X2	1	3	097	652.93
875-530C ¹	6X3	5	0	090	832.04
875-530CF [*]	6X3	1	2	097	725.94
875-532C	6X4	5	0	090	635.33
875-578C ¹	8X2	1	0	090	2200.71
875-578CF [*]	8X2	1	2	097	877.71
875-579CF [*]	8X2-1/2	1	2	097	919.94
875-580C ¹	8X3	1	0	090	2200.71
875-580CF [*]	8X3	1	2	097	899.54
875-582C ¹	8X4	1	0	090	2200.71
875-582CF [*]	8X4	1	2	097	923.86
875-585C ¹	8X6	1	0	090	2016.79
875-585CF [*]	8X6	1	0	097	1041.03
875-621CF [*]	10X2	1	0	097	977.78
875-623CF [*]	10X3	1	0	097	1040.93
875-624CF [*]	10X4	1	0	097	1272.08
875-626C	10X6	1	0	091	2273.47
875-626CF [*]	10X6	1	0	097	1444.36
875-628C	10X8	1	0	091	2393.72
875-628CF [*]	10X8	1	0	097	1700.86
875-661CF [*]	12X2	1	0	097	1613.25
875-663CF [*]	12X3	1	0	097	1694.85
875-664CF [*]	12X4	1	0	097	1933.34
875-666CF [*]	12X6	1	0	097	2011.19
875-668CF [*]	12X8	1	0	097	2122.81
875-670CF [*]	12X10	1	0	097	2613.59
875-694CF [*]	14X4	1	0	097	4327.35
875-696CF [*]	14X6	1	0	097	4753.01
875-698CF [*]	14X8	1	0	097	5141.54
875-702CF [*]	14X12	1	0	097	6263.59
875-754CF [*]	16X4	1	0	097	5445.08
875-756CF [*]	16X6	1	0	097	5733.40
875-758CF [*]	16X8	1	0	097	6657.34
875-760CF [*]	16X10	1	0	097	7481.91
875-762CF [*]	16X12	1	0	097	8114.48
875-764CF [*]	16X14	1	0	097	10207.76
875-784CF [*]	18X4	1	0	097	7279.23
875-786CF [*]	18X6	1	0	097	7812.35
875-788CF [*]	18X8	1	0	097	8672.77
875-790CF [*]	18X10	1	0	097	9561.44
875-792CF [*]	18X12	1	0	097	10515.23
875-794CF [*]	18X14	1	0	097	13388.92
875-796CF [*]	18X16	1	0	097	14909.73

¹ Sized with Bushing

* An asterisk (*) appearing after a fabricated fitting part number indicates the item is fiberglass reinforced.



Schedule 80 CPVC Industrial Products & Accessories
CPVC Schedule 80 Fittings

Part Number	Size	Std Pk	Mstr Ctn	Disc Code	Price Each
-------------	------	--------	----------	-----------	------------

Double Wye Soc



100 psi Maximum internal Pressure Rating @ 73°F (23°C)

876-020CF*	2	1	4	097	472.51
876-030CF*	3	1	4	097	602.69
876-040CF*	4	1	2	097	1033.38
876-060CF*	6	1	0	097	1801.69
876-080CF*	8	1	0	097	3231.25
876-100CF*	10	1	0	097	3506.62
876-120CF*	12	1	0	097	5253.80

* An asterisk (*) appearing after a fabricated fitting part number indicates the item is fiberglass reinforced.

For larger sizes please contact your Regional Spears® Distribution Center.

Reducing Double Wye Soc



Size 3" is 150 psi, all Fabricated Sizes- 100 psi Maximum Internal Pressure Rating @ 73°F (23°C)

876-338C	3X2	5	0	090	699.94
876-420CF*	4X2	1	2	097	880.53
876-421CF*	4X2-1/2	1	2	097	931.82
876-422CF*	4X3	1	2	097	1003.23
876-528CF*	6X2	1	3	097	1497.52
876-529CF*	6X2-1/2	1	2	097	1516.17
876-530CF*	6X3	1	2	097	1540.84
876-532CF*	6X4	1	0	097	1711.15
876-578CF*	8X2	1	2	097	2559.19
876-579CF*	8X2-1/2	1	2	097	2597.01
876-580CF*	8X3	1	2	097	2617.57
876-582CF*	8X4	1	0	097	2817.99
876-585CF*	8X6	1	0	097	2970.78
876-621CF*	10X2	1	0	097	3085.49
876-622CF*	10X2-1/2	1	0	097	3149.83
876-623CF*	10X3	1	0	097	3205.75
876-624CF*	10X4	1	0	097	3279.87
876-626CF*	10X6	1	0	097	3511.80
876-628CF*	10X8	1	0	097	3688.53
876-661CF*	12X2	1	0	097	3321.92
876-662CF*	12X2-1/2	1	0	097	3481.19
876-663CF*	12X3	1	0	097	3542.61
876-666CF*	12X6	1	0	097	4019.55
876-668CF*	12X8	1	0	097	4560.37
876-664CF*	12X4	1	0	097	3672.34
876-670CF*	12X10	1	0	097	4965.55

* An asterisk (*) appearing after a fabricated fitting part number indicates the item is fiberglass reinforced.

For larger sizes please contact your Regional Spears® Distribution Center.

Cross Soc

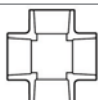

820-002C	1/4	25	150	090	60.36
820-005C	1/2	50	0	090	60.36
820-007C	3/4	50	0	090	63.53
820-010C	1	50	0	090	70.41
820-012C	1-1/4	25	0	090	75.34
820-015C	1-1/2	25	0	090	81.88
820-020C	2	10	0	090	106.21
820-025C	2-1/2	10	0	090	141.60
820-030C	3	5	0	090	180.33
820-040C	4	3	0	090	322.13
820-060CF	6	1	0	097	846.53
820-080CF	8	1	0	097	1610.20

Part Number	Size	Std Pk	Mstr Ctn	Disc Code	Price Each
-------------	------	--------	----------	-----------	------------

Cross (continued) Soc

820-100CF	10	1	0	097	2395.27
820-120CF	12	1	0	097	3403.32
820-140CF	14	1	0	097	9196.80
820-160CF	16	1	0	097	10962.05
820-180CF	18	1	0	097	14738.01

Reducing Cross Soc

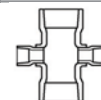

820-101C ¹	3/4X1/2	50	0	090	78.76
820-130C ¹	1X1/2	25	0	090	93.43
820-131C	1X3/4	20	0	090	93.43
820-166C ¹	1-1/4X1/2	25	0	090	83.58
820-167C	1-1/4X3/4	25	0	090	67.80
820-168C ¹	1-1/4X1	25	0	090	134.18
820-209C ¹	1-1/2X1/2	20	0	090	148.27
820-210C	1-1/2X3/4	15	0	090	148.27
820-211C ¹	1-1/2X1	25	0	090	148.27
820-212C ¹	1-1/2X1-1/4	25	0	090	148.27
820-247C ¹	2X1/2	10	0	090	191.97
820-248C ¹	2X3/4	10	0	090	191.97
820-249C ¹	2X1	10	0	090	191.97
820-250C ¹	2X1-1/4	10	0	090	191.97
820-251C ¹	2X1-1/2	10	0	090	191.97
820-289C	2-1/2X1	15	0	090	130.53
820-290C ¹	2-1/2X1-1/4	10	0	090	246.24
820-291C ¹	2-1/2X1-1/2	8	0	090	246.24
820-292C ¹	2-1/2X2	10	0	090	246.24
820-335C ¹	3X1	4	0	090	339.07
820-336C ¹	3X1-1/4	4	0	090	339.07
820-337C ¹	3X1-1/2	4	0	090	339.07
820-338C ¹	3X2	4	0	090	339.07
820-339C ¹	3X2-1/2	4	0	090	339.07
820-420C ¹	4X2	3	0	090	500.11
820-422C ¹	4X3	3	0	090	500.11
820-420CF	4X2	1	3	097	491.43
820-528CF	6X2	1	2	097	770.93
820-530CF	6X3	1	2	097	870.96
820-532CF	6X4	1	2	097	892.04
820-578CF	8X2	1	0	097	1004.62
820-580CF	8X3	1	0	097	1054.41
820-582CF	8X4	1	0	097	987.42
820-585CF	8X6	1	0	097	1297.36
820-621CF	10X2	1	0	097	1204.62
820-623CF	10X3	1	0	097	1295.17
820-624CF	10X4	1	0	097	1354.00
820-626CF	10X6	1	0	097	1617.54
820-628CF	10X8	1	0	097	1872.68
820-661CF	12X2	1	0	097	1470.85
820-663CF	12X3	1	0	097	1616.36
820-664CF	12X4	1	0	097	1706.59
820-666CF	12X6	1	0	097	1982.00
820-668CF	12X8	1	0	097	2311.97
820-670CF	12X10	0	0	097	2751.45
820-691CF	14X2	1	0	097	2832.47
820-693CF	14X3	1	0	097	2991.55
820-694CF	14X4	1	0	097	3124.42
820-696CF	14X6	1	0	097	4297.97
820-698CF	14X8	1	0	097	4887.06
820-700CF	14X10	1	0	097	5441.75
820-702CF	14X12	1	0	097	6203.71
820-751CF	16X2	1	0	097	4022.87
820-753CF	16X3	1	0	097	4191.95
820-754CF	16X4	1	0	097	4355.78
820-756CF	16X6	1	0	097	5783.51

Schedule 80 CPVC Industrial Products & Accessories
CPVC Schedule 80 Fittings



Part Number	Size	Std Pk	Mstr Ctn	Disc Code	Price Each
-------------	------	--------	----------	-----------	------------

Reducing Cross (continued)

Soc

820-758CF	16X8	1	0	097	6392.65
820-762CF	16X12	1	0	097	7493.28
820-764CF	16X14	1	0	097	9825.52
820-781CF	18X2	1	0	097	5388.40
820-783CF	18X3	1	0	097	5593.63
820-784CF	18X4	1	0	097	6502.03
820-786CF	18X6	1	0	097	7443.87
820-788CF	18X8	1	0	097	8128.11
820-790CF	18X10	1	0	097	8913.55
820-792CF	18X12	1	0	097	9678.52
820-794CF	18X14	1	0	097	12024.76
820-796CF	18X16	1	0	097	13482.28

¹ Sized with Bushing



Coupling Soc

829-002C	1/4	25	450	090	16.41
829-003C	3/8	25	150	090	16.41
829-005C	1/2	25	150	090	6.38
829-007C	3/4	15	90	090	8.92
829-010C	1	15	90	090	12.01
829-012C	1-1/4	10	80	090	17.99
829-015C	1-1/2	10	40	090	22.64
829-020C	2	20	0	090	26.32
829-025C	2-1/2	5	0	090	58.57
829-030C	3	5	0	090	63.64
829-040C	4	5	0	090	83.40
829-050C	5	6	0	090	186.61
829-060C	6	4	0	090	196.43
829-080C	8	4	0	090	530.87
829-100C	10	1	0	091	667.77
829-120C	12	1	0	091	782.13
829-140C	14	1	0	091	995.19
829-140CF	14	1	0	097	2195.46
829-160CF	16	1	0	097	3371.26
829-180CF	18	1	0	097	4169.98
829-200CF	20	1	0	097	5841.00
829-240CF	24	1	0	097	7299.48



Grooved Coupling Adapter
Groove x Soc

833-012C	1-1/4	10	60	090	28.71
833-015C	1-1/2	10	80	090	37.85
833-020C	2	5	40	090	49.20
833-025C	2-1/2	5	0	090	80.92
833-030C	3	5	0	090	99.77
833-040C	4	5	0	090	169.78
833-050CF	5	1	7	097	187.87
833-060C	6	5	0	090	242.87
833-080CF	8	1	4	097	306.32
833-100CF	10	1	0	097	480.74
833-120CF	12	1	0	097	678.01

Coupling Fipt



830-002C	1/4	25	450	090	20.62
830-003C	3/8	25	150	090	20.62
830-005C	1/2	25	150	090	16.97
830-007C	3/4	25	150	090	27.41
830-010C	1	15	90	090	31.12
830-012C	1-1/4	10	60	090	33.00

Part Number	Size	Std Pk	Mstr Ctn	Disc Code	Price Each
-------------	------	--------	----------	-----------	------------

Coupling (continued)

Fipt

830-015C	1-1/2	10	80	090	35.46
830-020C	2	10	0	090	41.80
830-025C	2-1/2	5	0	090	75.01
830-030C	3	5	0	090	87.32
830-040C	4	5	0	090	177.99
830-060CF	6	1	8	097	242.58

Special Reinforced Coupling
SR Fipt - Stainless Steel Collar

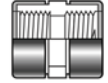

830-005CSR	1/2	25	300	096	9.31
830-007CSR	3/4	25	300	096	15.04
830-010CSR	1	25	200	096	17.08
830-012CSR	1-1/4	10	120	096	18.15
830-015CSR	1-1/2	10	80	096	19.46
830-020CSR	2	10	0	096	23.00

Reducer Coupling Soc



829-101C	3/4X1/2	50	400	090	16.69
829-130C	1X1/2	25	200	090	23.81
829-131C	1X3/4	25	200	090	23.81
829-166C	1-1/4X1/2	25	0	090	54.52
829-167C	1-1/4X3/4	25	0	090	54.52
829-168C	1-1/4X1	25	0	090	54.52
829-209C	1-1/2X1/2	25	0	090	54.08
829-210C	1-1/2X3/4	25	0	090	54.08
829-211C	1-1/2X1	25	0	090	54.08
829-212C	1-1/2X1-1/4	25	0	090	54.08
829-247C	2X1/2	25	0	090	71.52
829-248C	2X3/4	10	80	090	71.52
829-249C	2X1	10	40	090	71.52
829-250C	2X1-1/4	10	0	090	71.52
829-251C	2X1-1/2	10	40	090	71.52
829-291C	2-1/2X1-1/2	10	0	090	81.43
829-292C	2-1/2X2	10	0	090	81.43
829-335C ¹	3X1	8	0	090	201.41
829-336C ¹	3X1-1/4	6	0	090	207.57
829-337C ¹	3X1-1/2	8	0	090	207.57
829-338C	3X2	8	0	090	164.54
829-339C	3X2-1/2	5	0	090	165.23
829-339CF	3X2-1/2	1	9	097	156.98
829-416C ¹	4X3/4	4	0	090	237.27
829-417C ¹	4X1	4	0	090	237.27
829-419C ¹	4X1-1/2	4	0	090	237.27
829-420C	4X2	6	0	090	196.28
829-421C	4X2-1/2	4	0	090	196.28
829-422C	4X3	4	0	090	196.28
829-488CF	5X3	1	6	097	193.67
829-490CF	5X4	1	6	097	122.16
829-528C ¹	6X2	6	0	090	519.26
829-529C ¹	6X2-1/2	4	0	090	611.96
829-530C ¹	6X3	12	0	090	529.88
829-532C	6X4	4	0	090	445.86
829-580CF	8X3	1	6	097	472.21
829-582C ¹	8X4	2	0	090	809.06
829-582CF	8X4	1	4	097	418.63
829-585C	8X6	2	0	090	772.53
829-621CF	10X2	1	0	097	874.77
829-623CF	10X3	1	2	097	733.64
829-624CF	10X4	1	2	097	705.16
829-625CF	10X5	1	2	097	760.05
829-626C	10X6	1	0	091	1201.39
829-626CF	10X6	1	2	097	542.96



Schedule 80 CPVC Industrial Products & Accessories
CPVC Schedule 80 Fittings

Part Number	Size	Std Pk	Mstr Ctn	Disc Code	Price Each
Reducer Coupling (continued)					
Soc					
829-628C	10X8	1	0	091	1201.39
829-628CF	10X8	1	4	097	711.46
829-664CF	12X4	1	2	097	1569.53
829-665CF	12X5	1	0	097	1568.44
829-666CF	12X6	1	0	097	1459.73
829-668C	12X8	1	0	091	1308.97
829-668CF	12X8	1	0	097	1117.05
829-670CF	12X10	1	2	097	595.68
829-694CF	14X4	1	0	097	2278.63
829-696CF	14X6	1	0	097	2151.97
829-698CF	14X8	1	0	097	1791.60
829-700CF	14X10	1	0	097	1533.43
829-702CF	14X12	1	0	097	1341.43
829-754CF	16X4	1	0	097	2807.12
829-756CF	16X6	1	0	097	2889.01
829-758CF	16X8	1	0	097	3302.15
829-760CF	16X10	1	0	097	3162.98
829-762CF	16X12	1	0	097	2997.72
829-764CF	16X14	1	0	097	2663.35
829-783CF	18X3	1	0	097	5784.52
829-784CF	18X4	1	0	097	5739.07
829-786CF	18X6	1	0	097	5696.24
829-788CF	18X8	1	0	097	5572.34
829-790CF	18X10	1	0	097	5538.84
829-792CF	18X12	1	0	097	5444.07
829-794CF	18X14	1	0	097	5358.60
829-796CF	18X16	1	0	097	3911.68
829-818CF	20X8	1	0	097	5527.60
829-826CF	20X16	1	0	097	6318.89
829-828CF	20X18	1	0	097	5855.48
829-906CF	24X6	1	0	097	9250.31
829-918CF	24X18	1	0	097	12982.88
829-920CF	24X20	1	0	097	11684.48

¹ Sized with Bushing

Eccentric Reducer Coupling Soc



829-101CFE	3/4X1/2	1	15	097	37.02
829-130CFE	1X1/2	1	16	097	40.16
829-131CFE	1X3/4	1	15	097	38.64
829-168CFE	1-1/4X1	1	12	097	41.98
829-209CFE	1-1/2X1/2	1	10	097	66.49
829-210CFE	1-1/2X3/4	1	10	097	79.79
829-212CFE	1-1/2X1-1/4	1	20	097	43.98
829-249CFE	2X1	1	25	097	60.15
829-250CFE	2X1-1/4	1	25	097	54.75
829-251CFE	2X1-1/2	1	10	097	53.46
829-290CFE ²	2-1/2X1-1/4	1	10	097	91.27
829-291CFE ²	2-1/2X1-1/2	1	20	097	91.08
829-292CFE	2-1/2X2	1	10	097	64.68
829-335CFE ²	3X1	1	10	097	142.22
829-336CFE ²	3X1-1/4	1	10	097	135.81
829-337CFE ²	3X1-1/2	1	10	097	133.58
829-338CFE	3X2	1	20	097	86.60
829-339CFE	3X2-1/2	1	10	097	173.91
829-417CFE ³	4X1	1	18	097	219.44
829-418CFE ³	4X1-1/4	1	6	097	223.46
829-419CFE ³	4X1-1/2	1	6	097	211.48
829-420CFE ²	4X2	1	10	097	193.54
829-421CFE ²	4X2-1/2	1	6	097	178.65
829-422CFE	4X3	1	10	097	125.27
829-490CFE	5X4	1	8	097	148.45
829-528CFE ³	6X2	1	6	097	391.13
829-529CFE ³	6X2-1/2	1	4	097	364.35

Part Number	Size	Std Pk	Mstr Ctn	Disc Code	Price Each
Eccentric Reducer Coupling (continued)					
Soc					
829-530CFE ²	6X3	1	6	097	312.38
829-532CFE ²	6X4	1	10	097	265.92
829-578CFE ⁴	8X2	1	0	097	777.20
829-580CFE ³	8X3	1	2	097	701.37
829-582CFE ²	8X4	1	2	097	667.32
829-583CFE ²	8X5	1	2	097	594.73
829-585CFE	8X6	1	4	097	578.72
829-624CFE ³	10X4	1	0	097	1385.20
829-625CFE ³	10X5	1	0	097	1226.56
829-626CFE ²	10X6	1	2	097	1187.62
829-628CFE	10X8	1	2	097	853.23
829-664CFE ⁴	12X4	1	0	097	2495.13
829-666CFE ³	12X6	1	0	097	1630.43
829-668CFE ²	12X8	1	0	097	1554.99
829-670CFE	12X10	1	0	097	1391.57
829-696CFE ³	14X6	1	0	097	2699.17
829-698CFE ²	14X8	1	0	097	2646.46
829-700CFE	14X10	1	0	097	1886.47
829-702CFE	14X12	1	0	097	1722.29
829-756CFE ⁵	16X6	1	0	097	4930.12
829-758CFE ⁴	16X8	1	0	097	4766.78
829-760CFE ³	16X10	1	0	097	4679.29
829-762CFE ²	16X12	1	0	097	4495.34
829-764CFE	16X14	1	0	097	4135.80
829-786CFE ⁶	18X6	1	0	097	9506.57
829-788CFE ⁵	18X8	1	0	097	9374.63
829-790CFE ⁴	18X10	1	0	097	9011.52
829-792CFE ³	18X12	1	0	097	8332.43
829-794CFE ²	18X14	1	0	097	7739.49
829-796CFE	18X16	1	0	097	5932.67

Eccentric Reducer Coupling Footnotes

Multi-Step Configurations

The number after the part number denotes steps listed below.

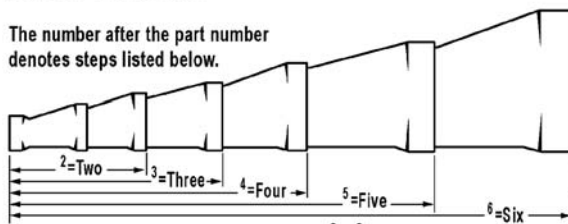

Reducer Coupling Fipt

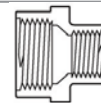

830-101C	3/4X1/2	50	200	090	27.80
----------	---------	----	-----	-----	-------

Special Reinforced Reducer Coupling SR Fipt - Stainless Steel Collar

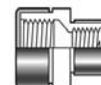

830-101CSR	3/4X1/2	50	200	096	16.68
830-130CSR	1X1/2	50	0	096	20.14
830-131CSR	1X3/4	25	200	096	20.14
830-168CSR	1-1/4X1	25	0	096	27.39
830-210CSR	1-1/2X3/4	25	0	096	39.17
830-211CSR	1-1/2X1	10	80	096	39.17
830-212CSR	1-1/2X1-1/4	10	80	096	39.17
830-249CSR	2X1	25	0	096	96.42
830-251CSR	2X1-1/2	15	0	096	96.42

Schedule 80 CPVC Industrial Products & Accessories
CPVC Schedule 80 Fittings



Part Number	Size	Std Pk	Mstr Ctn	Disc Code	Price Each
-------------	------	--------	----------	-----------	------------

Fabricated Repair Coupling Gasket



828-020CF	2	1	5	097	129.34
828-030CF	3	1	5	097	164.76
828-040CF	4	1	4	097	205.29
828-060CF	6	1	2	097	237.88
828-080CF	8	1	2	097	639.58
828-100CF	10	1	0	097	689.98
828-120CF	12	1	0	097	907.87
828-140CF	14	1	0	097	2672.22
828-160CF	16	1	0	097	3783.44

Female Adapter Soc x Fipt



835-002C	1/4	25	450	090	20.82
835-003C	3/8	25	150	090	20.82
835-005C	1/2	25	150	090	10.32
835-007C	3/4	15	90	090	10.22
835-010C	1	15	90	090	25.17
835-012C	1-1/4	10	120	090	25.77
835-015C	1-1/2	10	80	090	30.02
835-020C	2	10	0	090	51.74
835-025C	2-1/2	5	0	090	99.24
835-030C	3	5	0	090	203.62
835-040C	4	5	0	090	338.92
835-060C	6	6	0	090	481.18
835-060CF	6	1	8	097	304.80
835-080C	8	3	0	090	760.28
835-080CF	8	1	0	097	383.40
835-100CF	10	1	2	097	557.13
835-120CF	12	1	0	097	721.95

Special Reinforced Female Adapter Soc x SR Fipt - Stainless Steel Collar



835-002CSR	1/4	25	450	096	13.06
835-003CSR	3/8	25	300	096	13.06
835-005CSR	1/2	25	300	096	5.61
835-007CSR	3/4	25	150	096	6.06
835-010CSR	1	25	200	096	13.82
835-012CSR	1-1/4	10	60	096	14.18
835-015CSR	1-1/2	10	80	096	16.46
835-020CSR	2	10	0	096	23.39
835-025CSR	2-1/2	5	0	096	54.39
835-030CSR	3	15	0	096	111.75
835-040CSR	4	5	0	096	185.99
835-060CSR	6	6	0	096	290.55

Encapsulated Special Reinforced (SR) Female Adapter Soc x ESR Fipt



835-002CESR	1/4	25	450	096	16.57
835-003CESR	3/8	25	300	096	16.57
835-005CESR	1/2	25	300	096	8.60
835-007CESR	3/4	25	300	096	9.08
835-010CESR	1	25	200	096	20.01
835-012CESR	1-1/4	10	80	096	20.48
835-015CESR	1-1/2	10	0	096	26.52
835-020CESR	2	10	0	096	41.22

Part Number	Size	Std Pk	Mstr Ctn	Disc Code	Price Each
-------------	------	--------	----------	-----------	------------

Transition Female Adapter Soc x Fipt With Brass Thread Insert

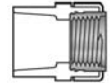

835-005CBR	1/2	25	150	096	31.64
835-007CBR	3/4	15	90	096	65.48
835-010CBR	1	15	90	096	114.92
835-012CBR	1-1/4	15	60	096	187.47
835-015CBR	1-1/2	10	80	096	247.18
835-020CBR	2	8	32	096	308.72

Not intended to convey or dispense water for human consumption through drinking or cooking

Transition Reducing Female Adapter Soc x Fipt With Brass Thread Insert

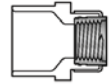

835-101CBR	3/4X1/2	50	0	096	45.81
------------	---------	----	---	-----	-------

Not intended to convey or dispense water for human consumption through drinking or cooking

Transition Female Adapter Soc x Fipt With Type 316 Stainless Steel Thread Insert

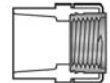

835-005CSS	1/2	25	150	096	62.13
835-007CSS	3/4	15	90	096	86.74
835-010CSS	1	15	90	096	151.81
835-012CSS	1-1/4	15	0	096	246.72
835-015CSS	1-1/2	10	60	096	321.87
835-020CSS	2	8	32	096	376.68

Transition Male Adapter w/Brass Thread Brass Mipt x Socket

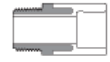

836-005CBR	1/2	40	160	096	70.14
836-007CBR	3/4	40	160	096	98.75
836-010CBR	1	10	60	096	171.99
836-012CBR	1-1/4	10	60	096	279.76
836-015CBR	1-1/2	10	40	096	363.71
836-020CBR	2	8	32	096	426.20

Special Reinforced Spigot Female Adapter Spig x SR Fipt - Stainless Steel Collar

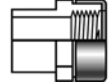

878-005CSR	1/2	50	600	096	5.98
878-007CSR	3/4	25	300	096	6.31
878-010CSR	1	50	0	096	14.19
878-012CSR	1-1/4	25	0	096	14.68
878-015CSR	1-1/2	25	0	096	17.04
878-020CSR	2	15	0	096	31.04
878-030CSR	3	5	0	096	113.15
878-040CSR	4	5	0	096	189.95

Special Reinforced Reducing Female Adapter Soc x SR Fipt - Stainless Steel Collar

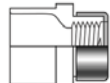

835-074CSR	1/2X3/4	50	400	096	6.06
835-101CSR	3/4X1/2	50	400	096	6.06
835-102CSR	3/4X1	50	0	096	13.82
835-130CSR	1X1/2	50	0	096	13.82
835-131CSR	1X3/4	25	200	096	13.82

Encapsulated Special Reinforced (SR) Female Adapter Spig x ESR Fipt

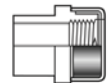

878-005CESR	1/2	50	600	096	8.85
878-007CESR	3/4	25	300	096	9.42
878-010CESR	1	50	0	096	20.20



Schedule 80 CPVC Industrial Products & Accessories
CPVC Schedule 80 Fittings

Part Number	Size	Std Pk	Mstr Ctn	Disc Code	Price Each
-------------	------	--------	----------	-----------	------------

Encapsulated Special Reinforced (SR) Female Adapter (continued)
Spig x ESR Fipt

878-012CESR	1-1/4	25	0	096	20.75
878-015CESR	1-1/2	25	0	096	27.05
878-020CESR	2	15	0	096	41.81

Special Reinforced Reducing Spigot Female Adapter

Spig x SR Fipt - Stainless Steel Collar



878-072CSR	1/2X1/4	25	450	096	17.14
878-098CSR	3/4X1/4	50	400	096	19.95
878-128CSR	1X1/4	50	400	096	22.33

Male Adapter

Mipt x Soc



836-005C	1/2	25	150	090	8.24
836-007C	3/4	25	150	090	10.05
836-102C	3/4X1	25	0	090	37.01
836-131C	1X3/4	25	0	090	35.15
836-010C	1	20	240	090	16.94
836-012C	1-1/4	10	60	090	24.97
836-015C	1-1/2	10	120	090	33.74
836-020C	2	10	80	090	45.77
836-025C	2-1/2	5	0	090	124.80
836-030C	3	5	0	090	167.71
836-040C	4	5	0	090	283.52
836-060C	6	5	0	090	406.34
836-060CF	6	1	8	097	287.99
836-080CF	8	1	2	097	367.68
836-100CF	10	1	2	097	681.27
836-120CF	12	1	0	097	792.82

Reinforced Male Adapter

R Mipt x Soc - Stainless Steel Sleeve

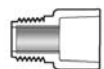

836-005CR	1/2	25	150	096	8.62
836-007CR	3/4	25	300	096	9.87
836-010CR	1	10	120	096	11.71

Male Adapter

Spig x Mipt



861-005C	1/2	50	300	090	10.04
861-007C	3/4	25	150	090	12.47
861-010C	1	50	0	090	21.16
861-131C	1X3/4	50	200	090	24.72
861-012C	1-1/4	25	200	090	24.00
861-015C	1-1/2	25	0	090	26.49
861-020C	2	25	0	090	31.00

Reducer (T.T.) Bushing Flush Style

Mipt x Fipt

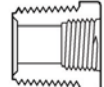

839-041C	1/4X1/8	25	500	090	19.25
839-052C	3/8X1/4	50	450	090	19.25
839-072C	1/2X1/4	50	300	090	19.25
839-073C	1/2X3/8	50	600	090	19.25
839-098C	3/4X1/4	50	300	090	21.22
839-099C	3/4X3/8	50	300	090	21.22
839-101C	3/4X1/2	50	300	090	9.13
839-128C	1X1/4	25	150	090	22.92
839-129C	1X3/8	50	600	090	22.92
839-130C	1X1/2	50	300	090	15.38
839-131C	1X3/4	50	700	090	15.38

Part Number	Size	Std Pk	Mstr Ctn	Disc Code	Price Each
-------------	------	--------	----------	-----------	------------

Reducer (T.T.) Bushing Flush Style (continued)

Mipt x Fipt

839-166C	1-1/4X1/2	25	150	090	30.55
839-167C	1-1/4X3/4	25	150	090	30.55
839-168C	1-1/4X1	25	300	090	30.31
839-209C	1-1/2X1/2	25	300	090	36.79
839-210C	1-1/2X3/4	25	300	090	36.79
839-211C	1-1/2X1	25	300	090	36.79
839-212C	1-1/2X1-1/4	25	300	090	36.51
839-247C	2X1/2	10	60	090	40.69
839-248C	2X3/4	10	60	090	40.69
839-249C	2X1	10	60	090	40.69
839-250C	2X1-1/4	10	60	090	40.69
839-251C	2X1-1/2	10	60	090	36.51
839-292C	2-1/2X2	10	40	090	97.82
839-337C	3X1-1/2	10	0	090	131.60
839-338C	3X2	10	0	090	131.60
839-339C	3X2-1/2	10	0	090	131.60
839-420C	4X2	6	0	090	226.13
839-422C	4X3	6	0	090	226.13
839-530C	6X3	5	0	090	816.33
839-532C	6X4	5	0	090	816.33

Special Reinforced Reducing Bushing

Mipt x SR Fipt - Stainless Steel Collar

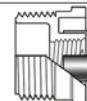

839-209CSR	1-1/2X1/2	25	300	096	22.11
839-210CSR	1-1/2X3/4	25	300	096	22.11
839-247CSR	2X1/2	10	60	096	24.43
839-248CSR	2X3/4	10	60	096	24.43
839-249CSR	2X1	10	120	096	24.43
839-420CSR	4X2	6	0	096	135.66

Reducer Bushing Flush Style

Spig x Soc



837-052C	3/8X1/4	50	450	090	13.34
837-072C	1/2X1/4	50	300	090	13.34
837-073C	1/2X3/8	50	300	090	13.34
837-101C	3/4X1/2	50	300	090	6.80
837-129C ¹	1X3/8	50	0	090	23.18
837-130C	1X1/2	50	400	090	10.57
837-131C	1X3/4	50	300	090	10.57
837-166C	1-1/4X1/2	25	300	090	28.06
837-167C	1-1/4X3/4	25	150	090	28.06
837-168C	1-1/4X1	25	150	090	28.06
837-209C	1-1/2X1/2	25	200	090	31.73
837-210C	1-1/2X3/4	25	200	090	31.73
837-211C	1-1/2X1	25	200	090	31.73
837-212C	1-1/2X1-1/4	25	200	090	31.73
837-247C	2X1/2	10	120	090	40.95
837-248C	2X3/4	10	60	090	40.95
837-249C	2X1	10	120	090	40.95
837-250C	2X1-1/4	10	60	090	40.95
837-251C	2X1-1/2	10	60	090	40.95
837-289C ¹	2-1/2X1	10	80	090	70.42
837-290C	2-1/2X1-1/4	10	80	090	49.87
837-291C	2-1/2X1-1/2	10	40	090	49.87
837-292C	2-1/2X2	15	0	090	49.87
837-334C ¹	3X3/4	10	0	090	86.86
837-335C	3X1	10	0	090	75.98
837-336C	3X1-1/4	10	0	090	75.98
837-337C	3X1-1/2	10	0	090	75.98
837-338C	3X2	10	0	090	75.98
837-339C	3X2-1/2	15	0	090	75.98
837-420C	4X2	6	0	090	84.01
837-421C ¹	4X2-1/2	6	0	090	84.01

Schedule 80 CPVC Industrial Products & Accessories
CPVC Schedule 80 Fittings



Part Number	Size	Std Pk	Mstr Ctn	Disc Code	Price Each
Reducer Bushing Flush Style (continued)					
Spig x Soc					
837-422C	4X3	6	0	090	84.01
837-490C	5X4	4	0	090	158.80
837-528C	6X2	5	0	090	180.23
837-529C ¹	6X2-1/2	5	0	090	261.44
837-530C	6X3	5	0	090	180.23
837-532C	6X4	5	0	090	178.97
837-578C ¹	8X2	4	0	090	777.03
837-580C ¹	8X3	4	0	090	777.03
837-582C	8X4	4	0	090	777.03
837-585C	8X6	4	0	090	589.20
837-621C ¹	10X2	2	0	091	1294.45
837-623C ¹	10X3	1	2	091	1294.45
837-624C ¹	10X4	4	0	091	1294.45
837-626C	10X6	4	0	091	1042.82
837-628C	10X8	4	0	091	1042.82
837-628CF	10X8	1	6	097	902.45
837-663CF	12X3	1	2	097	1461.81
837-664C ¹	12X4	2	0	091	2125.43
837-666CF	12X6	1	2	097	1250.18
837-668C	12X8	2	0	091	1314.74
837-670CF	12X10	1	3	097	941.39
837-696CF	14X6	1	3	097	3300.05
837-698CF	14X8	1	3	097	2300.68
837-700CF	14X10	1	3	097	1868.05
837-702CF	14X12	1	3	097	1353.71
837-756CF	16X6	1	2	097	5202.65
837-758CF	16X8	1	0	097	4863.02
837-760CF	16X10	1	0	097	3888.04
837-762CF	16X12	1	2	097	1977.99
837-764CF	16X14	1	2	097	1883.56
837-788CF	18X8	1	0	097	5762.54
837-796CF	18X16	1	0	097	2102.81

¹ Sized with Bushing

Reducer Bushing Flush Style
Spig x Fipt



838-052C	3/8X1/4	50	450	090	14.34
838-071C	1/2X1/8	50	600	090	14.34
838-072C	1/2X1/4	50	600	090	14.34
838-073C	1/2X3/8	50	300	090	14.34
838-098C	3/4X1/4	50	600	090	15.99
838-099C	3/4X3/8	50	600	090	15.99
838-101C	3/4X1/2	50	600	090	7.42
838-129C	1X3/8	50	400	090	21.23
838-130C	1X1/2	50	400	090	9.41
838-131C	1X3/4	50	400	090	9.41
838-166C	1-1/4X1/2	25	300	090	30.39
838-167C	1-1/4X3/4	25	300	090	30.39
838-168C	1-1/4X1	25	300	090	30.39
838-207C	1-1/2X1/4	25	200	090	37.43
838-209C	1-1/2X1/2	25	200	090	37.43
838-210C	1-1/2X3/4	25	200	090	37.43
838-211C	1-1/2X1	25	200	090	37.43
838-212C	1-1/2X1-1/4	25	200	090	37.43
838-247C	2X1/2	10	120	090	51.46
838-248C	2X3/4	10	60	090	51.46
838-249C	2X1	10	120	090	51.46
838-250C	2X1-1/4	10	120	090	51.46
838-251C	2X1-1/2	10	120	090	51.46
838-287C	2-1/2X1/2	10	0	090	82.33
838-288C	2-1/2X3/4	10	40	090	82.33
838-289C	2-1/2X1	10	40	090	82.33
838-290C	2-1/2X1-1/4	10	0	090	82.33
838-291C	2-1/2X1-1/2	10	40	090	81.77

Part Number	Size	Std Pk	Mstr Ctn	Disc Code	Price Each
Reducer Bushing Flush Style (continued)					
Spig x Fipt					
838-292C	2-1/2X2	10	40	090	81.77
838-334C	3X3/4	10	0	090	217.84
838-335C	3X1	10	0	090	217.84
838-336C	3X1-1/4	10	0	090	190.57
838-337C	3X1-1/2	10	0	090	190.57
838-338C	3X2	10	0	090	182.27
838-339C	3X2-1/2	10	0	090	183.75
838-420C	4X2	6	0	090	371.41
838-421C	4X2-1/2	6	0	090	371.41
838-422C	4X3	6	0	090	371.41
838-530C	6X3	5	0	090	748.81
838-532C	6X4	5	0	090	748.81

Special Reinforced Reducer Bushing
Spig x SR Fipt - Stainless Steel Collar



838-128CSR	1X1/4	25	150	096	12.74
838-207CSR	1-1/2X1/4	25	200	096	21.55
838-209CSR	1-1/2X1/2	10	120	096	22.46
838-210CSR	1-1/2X3/4	10	120	096	22.46
838-247CSR	2X1/2	10	80	096	30.86
838-248CSR	2X3/4	10	80	096	30.86
838-249CSR	2X1	10	80	096	30.86
838-334CSR	3X3/4	10	0	096	130.68
838-335CSR	3X1	10	0	096	130.68
838-336CSR	3X1-1/4	10	0	096	130.68
838-337CSR	3X1-1/2	10	0	096	130.68
838-528CSR	6X2	5	0	096	449.27
838-530CSR	6X3	5	0	096	449.27

Cap Soc



847-002C	1/4	25	450	090	10.98
847-003C	3/8	25	450	090	10.98
847-005C	1/2	25	150	090	9.94
847-007C	3/4	25	300	090	14.16
847-010C	1	15	90	090	25.05
847-012C	1-1/4	10	60	090	27.41
847-015C	1-1/2	10	60	090	27.41
847-020C	2	10	80	090	28.91
847-025C	2-1/2	5	40	090	97.32
847-030C	3	5	0	090	106.67
847-040C	4	5	0	090	108.43
847-060C	6	4	0	090	358.80
847-080C	8	3	0	090	1088.83
847-100CF	10	1	5	097	909.66
847-120CF	12	1	4	097	996.98
847-140CF	14	1	2	097	3058.07
847-160CF	16	1	2	097	4497.65

Cap Fipt



848-002C	1/4	25	450	090	12.85
848-003C	3/8	25	450	090	12.85
848-005C	1/2	25	150	090	11.04
848-007C	3/4	25	300	090	18.27
848-010C	1	15	90	090	25.58
848-012C	1-1/4	10	120	090	45.62
848-015C	1-1/2	10	120	090	46.74
848-020C	2	10	80	090	67.33
848-025C	2-1/2	5	40	090	155.79
848-030C	3	5	0	090	204.38
848-040C	4	5	0	090	296.89



Schedule 80 CPVC Industrial Products & Accessories
CPVC Schedule 80 Fittings

Part Number	Size	Std Pk	Mstr Ctn	Disc Code	Price Each
-------------	------	--------	----------	-----------	------------

Special Reinforced Cap
SR Fipt - Stainless Steel Collar



848-002CSR	1/4	25	500	096	7.06
848-003CSR	3/8	25	450	096	7.06
848-007CSR	3/4	25	300	096	11.00
848-030CSR	3	5	0	096	122.80

Plug
Spig



849-005C	1/2	50	300	090	12.65
849-007C	3/4	50	300	090	15.61
849-010C	1	50	200	090	17.61
849-012C	1-1/4	25	100	090	22.46
849-015C	1-1/2	10	120	090	24.64
849-020C	2	10	120	090	33.01
849-025CF ⁴	2-1/2	1	8	097	39.16
849-030CF ⁴	3	1	4	097	90.04
849-040CF ⁴	4	1	4	097	111.11
849-060CF ⁴	6	1	6	097	137.95
849-080CF ⁴	8	1	6	097	370.53
849-100CF ⁴	10	1	2	097	737.22
849-120CF ⁴	12	1	0	097	1428.84

⁴ Plug fabricated using Cap and pipe spigot.

Plug
Mipt



850-002C	1/4	50	900	090	10.34
850-003C	3/8	50	450	090	10.34
850-005C	1/2	50	500	090	8.98
850-007C	3/4	25	300	090	11.37
850-010C	1	15	180	090	18.71
850-012C	1-1/4	25	150	090	28.26
850-015C	1-1/2	25	150	090	23.44
850-020C	2	10	120	090	31.91
850-025C	2-1/2	5	30	090	54.17
850-030C	3	5	40	090	58.01
850-040C	4	5	0	090	102.93
850-060C	6	6	0	090	144.54
850-060CF ⁴	6	1	2	097	373.23
850-080CF ⁴	8	1	2	097	716.63
850-100CF ⁴	10	1	3	097	1034.35
850-120CF ⁴	12	1	0	097	1577.71

⁴ Plug fabricated using Cap and threaded pipe.

Union 2000
Soc with FKM O-ring Seal

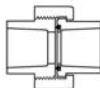

235 psi Maximum Internal Pressure Rating @ 73°F (23°C)

857-002C	1/4	25	150	090	41.15
857-003C	3/8	25	150	090	41.15
8057-005C	1/2	20	120	090	27.38
8057-007C	3/4	20	80	090	28.60
8057-010C	1	15	90	090	34.33
8057-012C	1-1/4	10	0	090	69.46
8057-015C	1-1/2	10	0	090	70.73
8057-020C	2	5	0	090	117.24
8057-025C	2-1/2	5	0	090	192.28
8057-030C	3	5	0	090	243.34
8057-040C	4	4	0	090	310.89
8057-060C	6	1	0	090	690.87

Part Number	Size	Std Pk	Mstr Ctn	Disc Code	Price Each
-------------	------	--------	----------	-----------	------------

Union 2000
Soc with EPDM O-ring Seal

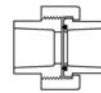

235 psi Maximum Internal Pressure Rating @ 73°F (23°C)

897-002C	1/4	25	150	090	40.65
897-003C	3/8	25	150	090	40.65
8097-005C	1/2	20	120	090	27.29
8097-007C	3/4	20	80	090	28.26
8097-010C	1	15	90	090	33.86
8097-012C	1-1/4	10	0	090	68.57
8097-015C	1-1/2	10	0	090	69.87
8097-020C	2	5	0	090	115.80
8097-025C	2-1/2	5	0	090	191.78
8097-030C	3	5	0	090	240.34
8097-040C	4	4	0	090	307.36
8097-060C	6	1	0	090	683.02

Union 2000
Soc x Fipt with FKM O-ring Seal

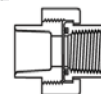

235 psi Maximum Internal Pressure Rating @ 73°F (23°C)

8059-005C	1/2	20	120	090	31.17
8059-007C	3/4	20	80	090	54.39
8059-010C	1	15	90	090	75.07
8059-012C	1-1/4	10	0	090	142.99
8059-015C	1-1/2	10	0	090	142.99
8059-020C	2	5	0	090	161.65
8059-025C	2-1/2	5	0	090	262.44
8059-030C	3	5	0	090	310.41
8059-040C	4	4	0	090	358.95
8059-060C	6	1	0	090	797.67

Union 2000
Soc x Fipt with EPDM O-ring Seal

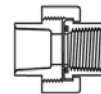

235 psi Maximum Internal Pressure Rating @ 73°F (23°C)

8099-005C	1/2	20	120	090	30.40
8099-007C	3/4	20	80	090	53.75
8099-010C	1	15	90	090	74.14
8099-012C	1-1/4	10	0	090	141.22
8099-015C	1-1/2	10	0	090	141.22
8099-020C	2	5	0	090	159.65
8099-025C	2-1/2	5	0	090	228.69
8099-030C	3	5	0	090	306.60
8099-040C	4	4	0	090	353.68
8099-060C	6	1	0	090	785.98

Union 2000
Soc x Spig with FKM O-ring Seal

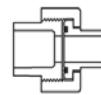

235 psi Maximum Internal Pressure Rating @ 73°F (23°C)

8056-005C	1/2	20	160	090	27.38
8056-007C	3/4	20	160	090	28.60
8056-010C	1	15	90	090	34.33
8056-012C	1-1/4	10	0	090	69.46
8056-015C	1-1/2	10	0	090	70.73
8056-020C	2	5	0	090	117.24
8056-025C	2-1/2	5	0	090	214.22
8056-030C	3	5	0	090	243.34
8056-040C	4	4	0	090	310.89
8056-060C	6	1	0	090	690.87

Schedule 80 CPVC Industrial Products & Accessories
CPVC Schedule 80 Fittings



Part Number	Size	Std Pk	Mstr Ctn	Disc Code	Price Each
-------------	------	--------	----------	-----------	------------

Union 2000
Soc x Spig with EPDM O-ring Seal

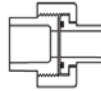

235 psi Maximum Internal Pressure Rating @ 73°F (23°C)

8096-005C	1/2	20	160	090	27.29
8096-007C	3/4	20	80	090	28.26
8096-010C	1	15	90	090	33.86
8096-012C	1-1/4	10	0	090	68.57
8096-015C	1-1/2	10	0	090	69.87
8096-020C	2	5	0	090	115.80
8096-025C	2-1/2	5	0	090	191.78
8096-030C	3	5	0	090	240.34
8096-040C	4	4	0	090	307.36
8096-060C	6	1	0	090	683.02

Union 2000
Fipt with FKM O-ring Seal

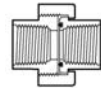

235 psi Maximum Internal Pressure Rating @ 73°F (23°C)

858-002C	1/4	25	150	090	46.27
858-003C	3/8	25	150	090	46.27
8058-005C	1/2	20	120	090	29.33
8058-007C	3/4	20	80	090	51.83
8058-010C	1	15	90	090	71.47
8058-012C	1-1/4	10	0	090	136.18
8058-015C	1-1/2	10	0	090	136.18
8058-020C	2	5	0	090	153.93
8058-025C	2-1/2	5	0	090	247.99
8058-030C	3	5	0	090	470.55
8058-040C	4	4	0	090	505.82
8058-060C	6	1	0	090	1124.07

Union 2000
Fipt with EPDM O-ring Seal

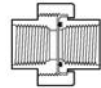

235 psi Maximum Internal Pressure Rating @ 73°F (23°C)

898-002C	1/4	25	150	090	45.72
898-003C	3/8	25	100	090	45.72
8098-005C	1/2	20	120	090	28.96
8098-007C	3/4	20	80	090	51.19
8098-010C	1	15	90	090	70.59
8098-012C	1-1/4	10	0	090	134.60
8098-015C	1-1/2	10	0	090	134.60
8098-020C	2	5	0	090	152.06
8098-025C	2-1/2	5	0	090	214.22
8098-030C	3	5	0	090	426.21
8098-040C	4	4	0	090	496.19
8098-060C	6	1	0	090	1102.63

Special Reinforced Union 2000
Soc x SR Fipt with FKM O-ring Seal

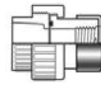

235 psi Maximum Internal Pressure Rating @ 73°F (23°C)

8059-005CSR	1/2	25	200	096	16.13
8059-007CSR	3/4	20	160	096	28.45
8059-010CSR	1	15	90	096	39.20
8059-012CSR	1-1/4	10	0	096	74.74
8059-015CSR	1-1/2	10	0	096	81.24
8059-020CSR	2	5	0	096	84.58
8059-025CSR	2-1/2	5	0	096	146.45
8059-030CSR	3	5	0	096	237.94
8059-040CSR	4	4	0	096	277.60
8059-060CSR	6	1	0	096	616.95

Part Number	Size	Std Pk	Mstr Ctn	Disc Code	Price Each
-------------	------	--------	----------	-----------	------------

Special Reinforced Union 2000
Soc x SR Fipt with EPDM O-ring Seal - Stainless Steel Collar

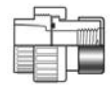

235 psi Maximum Internal Pressure Rating @ 73°F (23°C)

8099-005CSR	1/2	20	160	096	15.81
8099-007CSR	3/4	20	160	096	28.07
8099-010CSR	1	15	90	096	38.87
8099-012CSR	1-1/4	10	0	096	73.64
8099-015CSR	1-1/2	10	0	096	80.09
8099-020CSR	2	5	0	096	84.34
8099-025CSR	2-1/2	5	0	096	144.66
8099-030CSR	3	5	0	096	234.95
8099-040CSR	4	4	0	096	275.93
8099-060CSR	6	1	0	096	613.20

Special Reinforced Union 2000
SR Fipt with FKM O-ring Seal - Stainless Steel Collar

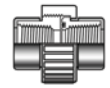

235 psi Maximum Internal Pressure Rating @ 73°F (23°C)

8058-005CSR	1/2	20	160	096	16.55
8058-007CSR	3/4	20	80	096	28.85
8058-010CSR	1	15	90	096	39.65
8058-012CSR	1-1/4	10	0	096	74.74
8058-015CSR	1-1/2	10	0	096	81.56
8058-020CSR	2	5	0	096	85.94
8058-030CSR	3	5	0	096	242.85
8058-040CSR	4	4	0	096	284.51
8058-060CSR	6	1	0	096	640.73

Special Reinforced Union 2000
SR Fipt with EPDM O-ring Seal - Stainless Steel Collar

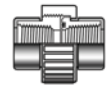

235 psi Maximum Internal Pressure Rating @ 73°F (23°C)

8098-005CSR	1/2	20	160	096	16.00
8098-007CSR	3/4	20	80	096	28.59
8098-010CSR	1	15	90	096	39.20
8098-012CSR	1-1/4	10	0	096	74.01
8098-015CSR	1-1/2	10	0	096	80.93
8098-020CSR	2	5	0	096	85.09
8098-025CSR	2-1/2	5	0	096	147.05
8098-030CSR	3	5	0	096	239.09
8098-040CSR	4	4	0	096	276.79
8098-060CSR	6	1	0	096	615.09

Union (Old Style)
Soc with FKM O-ring Seal

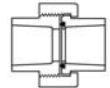

235 psi Maximum Internal Pressure Rating @ 73°F (23°C)

857-005C	1/2	15	90	090	27.38
857-007C	3/4	10	60	090	28.60
857-010C	1	10	40	090	34.33
857-012C	1-1/4	5	20	090	69.46
857-015C	1-1/2	5	0	090	70.73
857-020C	2	5	0	090	117.24
857-025C	2-1/2	5	0	090	192.28
857-030C	3	5	0	090	243.34
857-040C	4	4	0	090	310.89

Union (Old Style)
Soc with EPDM O-ring Seal

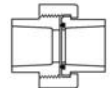

235 psi Maximum Internal Pressure Rating @ 73°F (23°C)

897-005C	1/2	15	90	090	27.29
897-007C	3/4	10	60	090	28.26
897-010C	1	10	40	090	33.86



Schedule 80 CPVC Industrial Products & Accessories
CPVC Schedule 80 Fittings

Part Number	Size	Std Pk	Mstr Ctn	Disc Code	Price Each
Union (Old Style) (continued)					
Soc with EPDM O-ring Seal					
897-012C	1-1/4	5	20	090	68.57
897-015C	1-1/2	5	0	090	69.87
897-020C	2	5	0	090	115.80
897-025C	2-1/2	5	0	090	191.78
897-030C	3	5	0	090	240.34
897-040C	4	4	0	090	307.36

Union (Old Style)
Soc x Fipt with FKM O-ring Seal

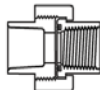

235 psi Maximum Internal Pressure Rating @ 73°F (23°C)

859-005C	1/2	15	90	090	31.17
859-007C	3/4	10	40	090	54.39
859-010C	1	10	40	090	75.07
859-012C	1-1/4	5	20	090	142.99
859-015C	1-1/2	5	0	090	142.99
859-020C	2	5	0	090	161.65
859-025C	2-1/2	5	0	090	262.44
859-030C	3	5	0	090	310.41
859-040C	4	4	0	090	358.95

Union (Old Style)
Soc x Fipt with EPDM O-ring Seal

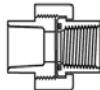

235 psi Maximum Internal Pressure Rating @ 73°F (23°C)

899-005C	1/2	15	90	090	30.40
899-007C	3/4	10	60	090	53.75
899-010C	1	10	40	090	74.14
899-012C	1-1/4	5	20	090	141.22
899-015C	1-1/2	5	0	090	141.22
899-020C	2	5	0	090	159.65
899-025C	2-1/2	5	0	090	228.69
899-030C	3	5	0	090	306.60
899-040C	4	4	0	090	353.68

Union
Soc x Fipt with Brass Thread Insert & FKM O-ring Seal

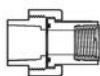

235 psi Maximum Internal Pressure Rating @ 73°F (23°C)

859-007CBR	3/4	10	20	096	146.17
859-010CBR	1	10	0	096	162.80
859-012CBR	1-1/4	5	0	096	272.91
859-015CBR	1-1/2	5	0	096	310.13
859-020CBR	2	5	0	096	350.51

Not intended to convey or dispense water for human consumption through drinking or cooking

Union
Soc x Fipt with Brass Thread Insert & EPDM O-ring Seal

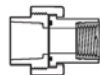

235 psi Maximum Internal Pressure Rating @ 73°F (23°C)

899-007CBR	3/4	10	40	096	143.69
899-010CBR	1	10	0	096	160.80
899-012CBR	1-1/4	5	20	096	269.46
899-015CBR	1-1/2	5	0	096	306.17
899-020CBR	2	5	0	096	346.21

Not intended to convey or dispense water for human consumption through drinking or cooking

Union (Old Style)
Fipt with FKM O-ring Seal

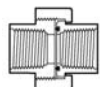

235 psi Maximum Internal Pressure Rating @ 73°F (23°C)

858-005C	1/2	15	90	090	29.33
858-007C	3/4	10	60	090	51.83

Part Number	Size	Std Pk	Mstr Ctn	Disc Code	Price Each
Union (Old Style) (continued)					
Fipt with FKM O-ring Seal					
858-010C	1	10	40	090	71.47
858-012C	1-1/4	5	20	090	136.18
858-015C	1-1/2	5	0	090	136.18
858-020C	2	5	0	090	153.93
858-025C	2-1/2	5	0	090	247.99
858-030C	3	5	0	090	470.55
858-040C	4	4	0	090	505.82

Union (Old Style)
Fipt with EPDM O-ring Seal

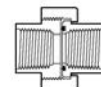

235 psi Maximum Internal Pressure Rating @ 73°F (23°C)

898-005C	1/2	15	90	090	28.96
898-007C	3/4	10	60	090	51.19
898-010C	1	10	40	090	70.59
898-012C	1-1/4	5	20	090	134.60
898-015C	1-1/2	5	0	090	134.60
898-020C	2	5	0	090	152.06
898-025C	2-1/2	5	0	090	214.22
898-030C	3	5	0	090	426.21
898-040C	4	4	0	090	496.19

Special Reinforced Union (Old Style)
Soc x SR Fipt with FKM O-ring Seal - Stainless Steel Collar

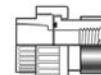

235 psi Maximum Internal Pressure Rating @ 73°F (23°C)

859-002CSR	1/4	25	150	096	25.38
859-003CSR	3/8	25	100	096	25.38
859-005CSR	1/2	10	60	096	16.13
859-007CSR	3/4	10	40	096	28.45
859-010CSR	1	10	40	096	39.20
859-012CSR	1-1/4	5	20	096	74.74
859-015CSR	1-1/2	5	0	096	81.24
859-020CSR	2	5	0	096	84.58
859-030CSR	3	5	0	096	237.94
859-040CSR	4	4	0	096	277.60

Special Reinforced Union (Old Style)
Soc x SR Fipt with EPDM O-ring Seal - Stainless Steel Collar

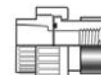

235 psi Maximum Internal Pressure Rating @ 73°F (23°C)

899-002CSR	1/4	25	150	096	25.21
899-003CSR	3/8	25	100	096	25.21
899-005CSR	1/2	10	60	096	15.81
899-007CSR	3/4	10	40	096	28.07
899-010CSR	1	10	40	096	38.87
899-012CSR	1-1/4	5	20	096	73.64
899-015CSR	1-1/2	5	0	096	80.09
899-020CSR	2	5	0	096	84.34
899-030CSR	3	5	0	096	234.95
899-040CSR	4	4	0	096	275.93



Spears® Two-Piece Clamp-On Saddle Design Clamps onto Pipe for Quick and Easy Installation



**Clamp-On Saddle
Installation Instructions**

1. Using a standard industrial grade hole-saw, cut specified hole in desired position on pipe according to recommended hole saw size engraved on the saddle. Note: Care must be taken to deburr hole and remove all residue from hole area to assure tight fit and avoid leakage.
2. Fully seat O-ring in groove on underside of saddle outlet component. Position over hole and fully seat saddle onto pipe. Note: Certain saddle outlets are piloted. Be sure pilot lip fully engages with hole in pipe.
3. Place strap component opposite outlet and secure with bolts (4), nuts (4) and washers (8). Important: Washers **MUST** be placed under each bolt head (1) and under each nut (1) to avoid damage to saddle.
4. Tighten bolts to specified torque.

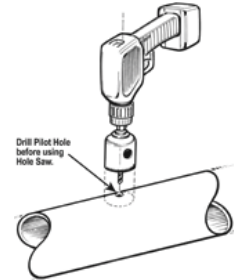

O-ring seal provides positive, trouble-free sealing to pipe.

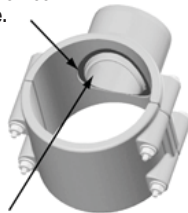

Special pilot engages with hole in pipe to prevent saddle dislocation.

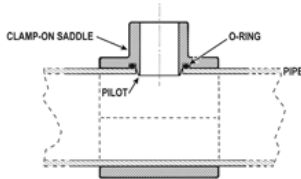

Saddle Size	2	3	4	6 & up
Recommended Bolt-Torque - ft/lb	8	8	8	10

For Double Outlet Saddle Installation — Determine second outlet hole position as shown.

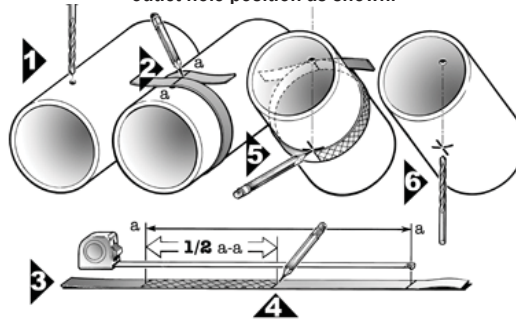

Spears® Hot-Tap Saddles Designed for Adding Branch Connections to Piping Systems Under Live (“Hot”) Pressure

Hot-Tap Saddle branch outlets are either 3/4" socket (with 1" Spigot O.D.) or 1-1/2" socket (with 2" Spigot O.D.) in saddle sizes 2" through 6" to fit IPS pipe using a built-in O-ring seal. Internal cutter is operated using conventional ratchet and drive extension and permanently retains coupon cut from pipe. Maximum operating pressure at 73°F (23°C) is 235 psi for saddle sizes 2" - 4", 200 psi for 6" saddles and 150 psi for 8" saddles. See packaged Installation Instructions for details.

Part Number	Size	Hole Saw Dia	Std Pk	Mstr Ctn	Disc Code	Price Each
-------------	------	--------------	--------	----------	-----------	------------

CPVC Gray Clamp-On Saddle x Soc Single Outlet

with FKM O-ring Seal & Zinc-Plated Hardware
2"- 4" 235, 6" 200, 8"-12" 150 psi @ 73°F (23°C)



866V-247C	2X1/2	3/4	1	10	096	56.69
866V-248C	2X3/4	7/8	1	10	096	56.69
866V-249C	2X1	1-1/8	1	10	096	56.69
866V-250C	2X1-1/4	1-1/2	1	10	096	56.69
866V-251C	2X1-1/2	1-1/2	1	10	096	56.69
866V-291C	2-1/2X1-1/2	1-3/4	1	10	096	78.78
866V-333C ¹	3X1/2	7/8	1	10	096	78.78
866V-334C	3X3/4	7/8	1	10	096	78.78
866V-335C	3X1	1-1/8	1	10	096	78.78
866V-336C ¹	3X1-1/4	2-1/4	1	10	096	78.78
866V-337C ¹	3X1-1/2	2-1/4	1	10	096	78.78
866V-338C	3X2	2-1/4	1	10	096	78.78

Part Number	Size	Hole Saw Dia	Std Pk	Mstr Ctn	Disc Code	Price Each
-------------	------	--------------	--------	----------	-----------	------------

CPVC Gray Clamp-On Saddle x Soc Single Outlet (continued) with FKM O-ring Seal & Zinc-Plated Hardware

866V-415C ¹	4X1/2	1-1/8	1	10	096	94.68
866V-416C ¹	4X3/4	1-1/8	1	10	096	94.68
866V-417C	4X1	1-1/8	1	8	096	94.68
866V-418C ¹	4X1-1/4	1-3/4	1	8	096	94.68
866V-419C	4X1-1/2	1-3/4	1	8	096	94.68
866V-420C	4X2	2-1/4	1	8	096	94.68
866V-421C ¹	4X2-1/2	3	1	4	096	101.65
866V-422C	4X3	3	1	4	096	110.83
866V-523C ¹	6X1/2	1-1/8	1	4	096	157.83
866V-524C ¹	6X3/4	1-1/8	1	4	096	157.83
866V-525C	6X1	1-1/8	1	4	096	157.83
866V-526C ¹	6X1-1/4	2-1/4	1	4	096	157.83
866V-527C ¹	6X1-1/2	2-1/4	1	4	096	157.83
866V-528C	6X2	2-1/4	1	4	096	157.83



Schedule 80 CPVC Industrial Products & Accessories
Clamp-On & Hot-Tap Saddles

Part Number	Size	Hole Saw Dia	Std Pk	Mstr Ctn	Disc Code	Price Each
-------------	------	--------------	--------	----------	-----------	------------

CPVC Gray Clamp-On Saddle x Soc Single Outlet

(continued)

with FKM O-ring Seal & Zinc-Plated Hardware

866V-529C ¹	6X2-1/2	3	1	4	096	170.81
866V-530C	6X3	3	1	4	096	181.83
866V-532C	6X4	4	1	4	096	193.74
866V-573C ¹	8X1/2	4	1	0	096	336.63
866V-574C ¹	8X3/4	4	1	0	096	336.63
866V-575C ¹	8X1	4	1	0	096	336.63
866V-576C ¹	8X1-1/4	4	1	0	096	336.63
866V-577C ¹	8X1-1/2	4	1	0	096	336.63
866V-578C ¹	8X2	4	1	0	096	336.63
866V-579C ¹	8X2-1/2	4	1	0	096	370.35
866V-580C ¹	8X3	4	1	0	096	388.59
866V-582C	8X4	4	1	0	096	423.16
866V-585C	8X6	6	1	0	096	581.80
866V-624C	10X4	4	1	0	096	544.26
866V-626C	10X6	6	1	0	096	625.79
866V-664C	12X4	4	1	0	096	682.22
866V-666C	12X6	6	1	0	096	723.15

¹Outlet-sized with Bushing

CPVC Gray Clamp-On Saddle x Soc Single Outlet

with FKM O-ring Seal & SS Hardware

2" - 4" 235, 6" 200, 8"-12" 150 psi @ 73°F (23°C)

866SV-247C	2X1/2	3/4	1	10	096	86.53
866SV-248C	2X3/4	7/8	1	10	096	86.53
866SV-249C	2X1	1-1/8	1	10	096	86.53
866SV-250C	2X1-1/4	1-1/2	1	10	096	86.53
866SV-251C	2X1-1/2	1-1/2	1	10	096	86.53
866SV-291C	2-1/2X1-1/2	1-3/4	1	10	096	115.91
866SV-333C ¹	3X1/2	7/8	1	10	096	115.91
866SV-334C	3X3/4	7/8	1	10	096	115.91
866SV-335C	3X1	1-1/8	1	10	096	115.91
866SV-336C ¹	3X1-1/4	2-1/4	1	10	096	115.91
866SV-337C ¹	3X1-1/2	2-1/4	1	10	096	115.91
866SV-338C	3X2	2-1/4	1	10	096	115.91
866SV-415C ¹	4X1/2	1-1/8	1	10	096	149.72
866SV-416C ¹	4X3/4	1-1/8	1	10	096	149.72
866SV-417C	4X1	1-1/8	1	8	096	149.72
866SV-418C ¹	4X1-1/4	1-3/4	1	8	096	149.72
866SV-419C	4X1-1/2	1-3/4	1	8	096	149.72
866SV-420C	4X2	2-1/4	1	8	096	149.72
866SV-421C ¹	4X2-1/2	3	1	4	096	158.46
866SV-422C	4X3	3	1	4	096	166.53
866SV-523C ¹	6X1/2	1-1/8	1	4	096	238.38
866SV-524C ¹	6X3/4	1-1/8	1	4	096	238.38
866SV-525C	6X1	1-1/8	1	4	096	238.38
866SV-526C ¹	6X1-1/4	2-1/4	1	4	096	238.38
866SV-527C ¹	6X1-1/2	2-1/4	1	4	096	238.38
866SV-528C	6X2	2-1/4	1	4	096	238.38
866SV-529C ¹	6X2-1/2	3	1	4	096	247.84
866SV-530C	6X3	3	1	4	096	256.44
866SV-532C	6X4	4	1	4	096	272.57
866SV-573C ¹	8X1/2	4	1	0	096	439.84
866SV-574C ¹	8X3/4	4	1	0	096	439.84
866SV-575C ¹	8 X 1	4	1	0	096	439.84
866SV-576C ¹	8X1-1/4	4	1	0	096	439.84
866SV-577C ¹	8X1-1/2	4	1	0	096	439.84
866SV-578C ¹	8 X 2	4	1	0	096	439.84
866SV-579C ¹	8X2-1/2	4	1	0	096	465.56
866SV-580C ¹	8X3	4	1	0	096	508.13
866SV-582C	8X4	4	1	0	096	538.59
866SV-585C	8X6	6	1	0	096	597.76
866SV-624C	10X4	4	1	0	096	711.28
866SV-626C	10X6	6	1	0	096	818.09



Part Number	Size	Hole Saw Dia	Std Pk	Mstr Ctn	Disc Code	Price Each
-------------	------	--------------	--------	----------	-----------	------------

CPVC Gray Clamp-On Saddle x Soc Single Outlet

(continued)

with FKM O-ring Seal & SS Hardware

866SV-664C	12X4	4	1	0	096	891.57
866SV-666C	12X6	6	1	0	096	1034.33

¹Outlet-sized with Bushing

CPVC Gray Clamp-On Saddle x Soc Single Outlet

with EPDM O-ring Seal & Zinc-Plated Hardware

2" - 4" 235, 6" 200, 8"-12" 150 psi @ 73°F (23°C)

866-247C	2X1/2	3/4	1	10	096	53.87
866-248C	2X3/4	7/8	1	10	096	53.87
866-249C	2X1	1-1/8	1	10	096	53.87
866-250C	2X1-1/4	1-1/2	1	10	096	53.87
866-251C	2X1-1/2	1-1/2	1	10	096	53.87
866-291C	2-1/2X1-1/2	1-3/4	1	10	096	72.17
866-333C ¹	3X1/2	7/8	1	10	096	72.17
866-334C	3X3/4	7/8	1	10	096	72.17
866-335C	3X1	1-1/8	1	10	096	72.17
866-336C ¹	3X1-1/4	2-1/4	1	10	096	72.17
866-337C ¹	3X1-1/2	2-1/4	1	10	096	72.17
866-338C	3X2	2-1/4	1	10	096	72.17
866-415C ¹	4X1/2	1-1/8	1	10	096	87.75
866-416C ¹	4X3/4	1-1/8	1	10	096	87.75
866-417C	4X1	1-1/8	1	8	096	87.75
866-418C ¹	4X1-1/4	1-3/4	1	8	096	87.75
866-419C	4X1-1/2	1-3/4	1	8	096	87.75
866-420C	4X2	2-1/4	1	8	096	87.75
866-421C ¹	4X2-1/2	3	1	4	096	96.38
866-422C	4X3	3	1	4	096	107.43
866-523C ¹	6X1/2	1-1/8	1	4	096	146.44
866-524C ¹	6X3/4	1-1/8	1	4	096	146.44
866-525C	6X1	1-1/8	1	4	096	146.44
866-526C ¹	6X1-1/4	2-1/4	1	4	096	146.44
866-527C ¹	6X1-1/2	2-1/4	1	4	096	146.44
866-528C	6X2	2-1/4	1	4	096	146.44
866-529C ¹	6X2-1/2	3	1	4	096	159.19
866-530C	6X3	3	1	4	096	170.76
866-532C	6X4	4	1	4	096	182.49
866-573C ¹	8X1/2	4	1	0	096	322.01
866-574C ¹	8X3/4	4	1	0	096	322.01
866-575C ¹	8X1	4	1	0	096	322.01
866-576C ¹	8X1-1/4	4	1	0	096	322.01
866-577C ¹	8X1-1/2	4	1	0	096	322.01
866-578C ¹	8X2	4	1	0	096	322.01
866-579C ¹	8X2-1/2	4	1	0	096	354.19
866-580C ¹	8X3	4	1	0	096	371.99
866-582C	8X4	4	1	0	096	394.27
866-585C	8X6	6	1	0	096	437.61
866-624C	10X4	4	1	0	096	520.69
866-626C	10X6	4	1	0	096	598.87
866-664C	12X4	4	1	0	096	652.81
866-666C	12X6	6	1	0	096	757.21

¹Outlet-sized with Bushing

CPVC Gray Clamp-On Saddle x Soc Single Outlet

with EPDM O-ring Seal & SS Hardware

2" - 4" 235, 6" 200, 8"-12" 150 psi @ 73°F (23°C)

866S-247C	2X1/2	3/4	1	10	096	83.87
866S-248C	2X3/4	7/8	1	10	096	83.87
866S-249C	2X1	1-1/8	1	10	096	83.87
866S-250C	2X1-1/4	1-1/2	1	10	096	83.87
866S-251C	2X1-1/2	1-1/2	1	10	096	83.87
866S-291C	2-1/2X1-1/2	1-3/4	1	10	096	111.81
866S-333C ¹	3X1/2	7/8	1	10	096	111.81



Schedule 80 CPVC Industrial Products & Accessories
Clamp-On & Hot-Tap Saddles



Part Number	Size	Hole Saw Dia	Std Pk	Mstr Ctn	Disc Code	Price Each
-------------	------	--------------	--------	----------	-----------	------------

CPVC Gray Clamp-On Saddle x Soc Single Outlet

(continued)
 with EPDM O-ring Seal & SS Hardware

866S-334C	3X3/4	7/8	1	10	096	111.81
866S-335C	3X1	1-1/8	1	10	096	111.81
866S-336C ¹	3X1-1/4	2-1/4	1	10	096	111.81
866S-337C ¹	3X1-1/2	2-1/4	1	10	096	111.81
866S-338C	3X2	2-1/4	1	10	096	111.81
866S-415C ¹	4X1/2	1-1/8	1	10	096	143.04
866S-416C ¹	4X3/4	1-1/8	1	10	096	143.04
866S-417C	4X1	1-1/8	1	8	096	143.04
866S-418C ¹	4X1-1/4	1-3/4	1	8	096	143.04
866S-419C	4X1-1/2	1-3/4	1	8	096	143.04
866S-420C	4X2	2-1/4	1	8	096	143.04
866S-421C ¹	4X2-1/2	3	1	4	096	149.07
866S-422C	4X3	3	1	4	096	156.73
866S-523C ¹	6X1/2	1-1/8	1	4	096	225.40
866S-524C ¹	6X3/4	1-1/8	1	4	096	225.40
866S-525C	6X1	1-1/8	1	4	096	225.40
866S-526C ¹	6X1-1/4	2-1/4	1	4	096	225.40
866S-527C ¹	6X1-1/2	2-1/4	1	4	096	225.40
866S-528C	6X2	2-1/4	1	4	096	225.40
866S-529C ¹	6X2-1/2	3	1	4	096	238.58
866S-530C	6X3	3	1	4	096	253.05
866S-532C	6X4	4	1	4	096	264.72
866S-573C ¹	8X1/2	4	1	0	096	423.32
866S-574C ¹	8X3/4	4	1	0	096	423.32
866S-575C ¹	8X1	4	1	0	096	423.32
866S-576C ¹	8X1-1/4	4	1	0	096	423.32
866S-577C ¹	8X1-1/2	4	1	0	096	423.32
866S-578C ¹	8 X 2	4	1	0	096	423.32
866S-579C ¹	8X2-1/2	4	1	0	096	465.56
866S-580C ¹	8X3	4	1	0	096	488.87
866S-582C	8X4	4	1	0	096	518.21
866S-585C	8X6	6	1	0	096	575.04
866S-624C	10X4	4	1	0	096	684.27
866S-626C	10X6	6	1	0	096	786.97
866S-664C	12X4	4	1	0	096	857.68
866S-666C	12X6	6	1	0	096	994.95

¹Outlet-sized with Bushing

CPVC Gray Clamp-On Saddle x SR Thread Single Outlet

with FKM O-ring Seal & Zinc-Plated Hardware

2"- 4" 235, 6" 200, 8"-12" 150 psi @ 73°F (23°C)



867V-247CSR	2X1/2	3/4	1	10	096	64.91
867V-248CSR	2X3/4	7/8	1	10	096	64.91
867V-249CSR	2X1	1-1/8	1	10	096	64.91
867V-250CSR	2X1-1/4	1-1/2	1	10	096	64.91
867V-251CSR	2X1-1/2	1-1/2	1	10	096	64.91
867V-291CSR	2-1/2X1-1/2	1-3/4	1	10	096	90.57
867V-333CSR ¹	3X1/2	7/8	1	10	096	90.57
867V-334CSR	3X3/4	7/8	1	10	096	90.57
867V-335CSR	3X1	1-1/8	1	10	096	90.57
867V-336CSR ¹	3X1-1/4	2-1/4	1	10	096	90.57
867V-337CSR ¹	3X1-1/2	2-1/4	1	10	096	90.57
867V-338CSR	3X2	2-1/4	1	10	096	90.57
867V-415CSR ¹	4X1/2	1-1/8	1	10	096	112.95
867V-416CSR ¹	4X3/4	1-1/8	1	10	096	112.95
867V-417CSR	4X1	1-1/8	1	8	096	112.95
867V-418CSR ¹	4X1-1/4	1-3/4	1	8	096	112.95
867V-419CSR	4X1-1/2	1-3/4	1	8	096	112.95
867V-420CSR	4X2	2-1/4	1	8	096	112.95
867V-421CSR ¹	4X2-1/2	3	1	4	096	121.83
867V-422CSR	4X3	3	1	4	096	134.12
867V-523CSR ¹	6X1/2	1-1/8	1	4	096	188.72
867V-524CSR ¹	6X3/4	1-1/8	1	4	096	188.72

Part Number	Size	Hole Saw Dia	Std Pk	Mstr Ctn	Disc Code	Price Each
-------------	------	--------------	--------	----------	-----------	------------

CPVC Gray Clamp-On Saddle x SR Thread Single Outlet

(continued)
 with FKM O-ring Seal & Zinc-Plated Hardware

867V-525CSR	6X1	1-1/8	1	4	096	188.72
867V-526CSR ¹	6X1-1/4	2-1/4	1	4	096	188.72
867V-527CSR ¹	6X1-1/2	2-1/4	1	4	096	188.72
867V-528CSR	6X2	2-1/4	1	4	096	188.72
867V-529CSR ¹	6X2-1/2	3	1	4	096	202.08
867V-530CSR	6X3	3	1	4	096	209.36
867V-532CSR	6X4	4	1	4	096	224.25
867V-573CSR ¹	8X1/2	4	1	0	096	376.20
867V-574CSR ¹	8X3/4	4	1	0	096	376.20
867V-575CSR ¹	8X1	4	1	0	096	376.20
867V-576CSR ¹	8X1-1/4	4	1	0	096	376.20
867V-577CSR ¹	8X1-1/2	4	1	0	096	376.20
867V-578CSR ¹	8X2	4	1	0	096	376.20
867V-579CSR ¹	8X2-1/2	4	1	0	096	413.79
867V-580CSR ¹	8X3	4	1	0	096	434.52
867V-582CSR	8X4	4	1	0	096	462.31
867V-585CSR	8X6	6	1	0	096	476.68
867V-624CSR	10X4	4	1	0	096	550.02
867V-626CSR	10X6	6	1	0	096	632.49
867V-664CSR	12X4	4	1	0	096	688.06
867V-666CSR	12X6	6	1	0	096	799.87

¹Outlet-sized with Bushing

CPVC Gray Clamp-On Saddle x SR Thread Single Outlet

with FKM O-ring Seal & SS Hardware

2"- 4" 235, 6" 200, 8"-12" 150 psi @ 73°F (23°C)

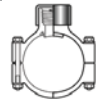

867SV-245CSR ¹	2X1/4	1-1/8	1	10	096	112.88
867SV-247CSR	2X1/2	3/4	1	10	096	107.72
867SV-248CSR	2X3/4	7/8	1	10	096	107.72
867SV-249CSR	2X1	1-1/8	1	10	096	107.72
867SV-250CSR	2X1-1/4	1-1/2	1	10	096	107.72
867SV-251CSR	2X1-1/2	1-1/2	1	10	096	107.72
867SV-291CSR	2-1/2X1-1/2	1-3/4	1	10	096	144.71
867SV-331CSR ¹	3X1/4	1-1/8	1	10	096	152.98
867SV-333CSR ¹	3X1/2	7/8	1	10	096	144.71
867SV-334CSR	3X3/4	7/8	1	10	096	144.71
867SV-335CSR	3X1	1-1/8	1	10	096	144.71
867SV-336CSR ¹	3X1-1/4	2-1/4	1	10	096	144.71
867SV-337CSR ¹	3X1-1/2	2-1/4	1	10	096	144.71
867SV-338CSR	3X2	2-1/4	1	10	096	144.71
867SV-413CSR ¹	4X1/4	1-1/8	1	8	096	182.83
867SV-415CSR ¹	4X1/2	1-1/8	1	10	096	182.83
867SV-416CSR ¹	4X3/4	1-1/8	1	10	096	182.83
867SV-417CSR	4X1	1-1/8	1	8	096	182.83
867SV-418CSR ¹	4X1-1/4	1-3/4	1	8	096	182.83
867SV-419CSR	4X1-1/2	1-3/4	1	8	096	182.83
867SV-420CSR	4X2	2-1/4	1	8	096	182.83
867SV-421CSR ¹	4X2-1/2	3	1	4	096	190.21
867SV-422CSR	4X3	3	1	4	096	200.52
867SV-521CSR ¹	6X1/4	1-1/8	1	4	096	316.48
867SV-523CSR ¹	6X1/2	1-1/8	1	4	096	304.72
867SV-524CSR ¹	6X3/4	1-1/8	1	4	096	304.72
867SV-525CSR	6X1	1-1/8	1	4	096	304.72
867SV-526CSR ¹	6X1-1/4	2-1/4	1	4	096	304.72
867SV-527CSR ¹	6X1-1/2	2-1/4	1	4	096	304.72
867SV-528CSR	6X2	2-1/4	1	4	096	304.72
867SV-529CSR ¹	6X2-1/2	3	1	4	096	319.23
867SV-530CSR	6X3	3	1	4	096	332.09
867SV-532CSR	6X4	4	1	4	096	355.49
867SV-571CSR ¹	8X1/4	4	1	0	096	538.42
867SV-573CSR ¹	8X1/2	4	1	0	096	524.93
867SV-574CSR ¹	8X3/4	4	1	0	096	524.93
867SV-575CSR ¹	8X1	4	1	0	096	524.93



Schedule 80 CPVC Industrial Products & Accessories
Clamp-On & Hot-Tap Saddles

Part Number	Size	Hole Saw Dia	Std Pk	Mstr Ctn	Disc Code	Price Each
-------------	------	--------------	--------	----------	-----------	------------

CPVC Gray Clamp-On Saddle x SR Thread Single Outlet
(continued)
with FKM O-ring Seal & SS Hardware

867SV-576CSR ¹	8X1-1/4	4	1	0	096	524.93
867SV-577CSR ¹	8X1-1/2	4	1	0	096	524.93
867SV-578CSR ¹	8X2	4	1	0	096	524.93
867SV-579CSR ¹	8X2-1/2	4	1	0	096	577.46
867SV-580CSR ¹	8X3	4	1	0	096	606.36
867SV-582CSR	8X4	4	1	0	096	642.81
867SV-585CSR	8X6	6	1	0	096	676.71
867SV-624CSR	10X4	4	1	0	096	764.96
867SV-626CSR	10X6	6	1	0	096	879.68
867SV-664CSR	12X4	4	1	0	096	958.82
867SV-666CSR	12X6	6	1	0	096	1112.24

¹Outlet-sized with Bushing

CPVC Gray Clamp-On Saddle x SR Thread Single Outlet
with EPDM O-ring Seal & Zinc-Plated Hardware

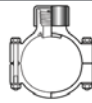

2"- 4" 235, 6" 200, 8"-12" 150 psi @ 73°F (23°C)

867-247CSR	2X1/2	3/4	1	10	096	56.35
867-248CSR	2X3/4	7/8	1	10	096	56.35
867-249CSR	2X1	1-1/8	1	10	096	56.35
867-250CSR	2X1-1/4	1-1/2	1	10	096	56.35
867-251CSR	2X1-1/2	1-1/2	1	10	096	56.35
867-291CSR	2-1/2X1-1/2	1-3/4	1	10	096	77.01
867-333CSR ¹	3X1/2	7/8	1	10	096	77.01
867-334CSR	3X3/4	7/8	1	10	096	77.01
867-335CSR	3X1	1-1/8	1	10	096	77.01
867-336CSR ¹	3X1-1/4	2-1/4	1	10	096	77.01
867-337CSR ¹	3X1-1/2	2-1/4	1	10	096	77.01
867-338CSR	3X2	2-1/4	1	10	096	77.01
867-415CSR ¹	4X1/2	1-1/8	1	10	096	96.99
867-416CSR ¹	4X3/4	1-1/8	1	10	096	96.99
867-417CSR	4X1	1-1/8	1	8	096	96.99
867-418CSR ¹	4X1-1/4	1-3/4	1	8	096	96.99
867-419CSR	4X1-1/2	1-3/4	1	8	096	96.99
867-420CSR	4X2	2-1/4	1	8	096	96.99
867-421CSR ¹	4X2-1/2	3	1	4	096	107.62
867-422CSR	4X3	3	1	4	096	116.16
867-523CSR ¹	6X1/2	1-1/8	1	4	096	161.62
867-524CSR ¹	6X3/4	1-1/8	1	4	096	161.62
867-525CSR	6X1	1-1/8	1	4	096	161.62
867-526CSR ¹	6X1-1/4	2-1/4	1	4	096	161.62
867-527CSR ¹	6X1-1/2	2-1/4	1	4	096	161.62
867-528CSR	6X2	2-1/4	1	4	096	161.62
867-529CSR ¹	6X2-1/2	3	1	4	096	171.02
867-530CSR	6X3	3	1	4	096	180.84
867-532CSR	6X4	4	1	4	096	196.66
867-573CSR ¹	8X1/2	4	1	0	096	341.54
867-574CSR	8X3/4	4	1	0	096	341.54
867-575CSR ¹	8X1	4	1	0	096	341.54
867-576CSR ¹	8X1-1/4	4	1	0	096	341.54
867-577CSR ¹	8X1-1/2	4	1	0	096	341.54
867-578CSR ¹	8X2	4	1	0	096	341.54
867-579CSR ¹	8X2-1/2	4	1	0	096	375.68
867-580CSR ¹	8X3	4	1	0	096	398.22
867-582CSR	8X4	4	1	0	096	422.21
867-585CSR	8X6	6	1	0	096	438.98
867-624CSR	10X4	4	1	0	096	502.46
867-626CSR	10X6	6	1	0	096	577.79
867-664CSR	12X4	4	1	0	096	629.83
867-666CSR	12X6	6	1	0	096	730.55

¹Outlet-sized with Bushing

Part Number	Size	Hole Saw Dia	Std Pk	Mstr Ctn	Disc Code	Price Each
-------------	------	--------------	--------	----------	-----------	------------

CPVC Gray Clamp-On Saddle x SR Thread Single Outlet

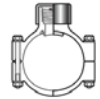

with EPDM O-ring Seal & SS Hardware

2"- 4" 235, 6" 200, 8"-12" 150 psi @ 73°F (23°C)

867S-245CSR ¹	2X1/4	1-1/8	1	10	096	99.36
867S-247CSR	2X1/2	3/4	1	10	096	96.75
867S-248CSR	2X3/4	7/8	1	10	096	96.75
867S-249CSR	2X1	1-1/8	1	10	096	96.75
867S-250CSR	2X1-1/4	1-1/2	1	10	096	96.75
867S-251CSR	2X1-1/2	1-1/2	1	10	096	96.75
867S-291CSR	2-1/2X1-1/2	1-3/4	1	10	096	129.51
867S-331CSR ¹	3X1/4	1-1/8	1	10	096	133.62
867S-333CSR ¹	3X1/2	7/8	1	10	096	129.51
867S-334CSR	3X3/4	7/8	1	10	096	129.51
867S-335CSR	3X1	1-1/8	1	10	096	129.51
867S-336CSR ¹	3X1-1/4	2-1/4	1	10	096	129.51
867S-337CSR ¹	3X1-1/2	2-1/4	1	10	096	129.51
867S-338CSR	3X2	2-1/4	1	10	096	129.51
867S-413CSR ¹	4X1/4	1-1/8	1	8	096	167.96
867S-415CSR ¹	4X1/2	1-1/8	1	10	096	162.99
867S-416CSR ¹	4X3/4	1-1/8	1	10	096	162.99
867S-417CSR	4X1	1-1/8	1	8	096	162.99
867S-418CSR ¹	4X1-1/4	1-3/4	1	8	096	162.99
867S-419CSR	4X1-1/2	1-3/4	1	8	096	162.99
867S-420CSR	4X2	2-1/4	1	8	096	162.99
867S-421CSR ¹	4X2-1/2	3	1	4	096	172.83
867S-422CSR	4X3	3	1	4	096	180.95
867S-521CSR ¹	6X1/4	1-1/8	1	8	096	281.78
867S-523CSR ¹	6X1/2	1-1/8	1	4	096	271.65
867S-524CSR ¹	6X3/4	1-1/8	1	4	096	271.65
867S-525CSR	6X1	1-1/8	1	4	096	271.65
867S-526CSR ¹	6X1-1/4	2-1/4	1	4	096	271.65
867S-527CSR ¹	6X1-1/2	2-1/4	1	4	096	271.65
867S-528CSR	6X2	2-1/4	1	4	096	271.65
867S-529CSR ¹	6X2-1/2	3	1	4	096	282.51
867S-530CSR	6X3	3	1	4	096	291.98
867S-532CSR	6X4	4	1	4	096	304.85
867S-571CSR ¹	8X1/4	4	1	0	096	500.37
867S-573CSR	8X1/2	4	1	0	096	482.60
867S-574CSR ¹	8X3/4	4	1	0	096	482.60
867S-575CSR ¹	8X1	4	1	0	096	482.60
867S-576CSR ¹	8X1-1/4	4	1	0	096	482.60
867S-577CSR ¹	8X1-1/2	4	1	0	096	482.60
867S-578CSR ¹	8X2	4	1	0	096	482.60
867S-579CSR ¹	8X2-1/2	4	1	0	096	530.84
867S-580CSR ¹	8X3	4	1	0	096	557.34
867S-582CSR	8X4	4	1	0	096	590.77
867S-585CSR	8X6	6	1	0	096	619.69
867S-624CSR	10X4	4	1	0	096	703.02
867S-626CSR	10X6	6	0	0	096	808.48
867S-664CSR	12X4	4	1	0	096	881.24
867S-666CSR	12X6	6	1	0	096	1022.27

¹Outlet-sized with Bushing

CPVC Gray Clamp-On Saddle x Soc Double Outlet



with FKM O-ring Seal & Zinc-Plated Hardware

2"- 4" 235, 6" 200, 8"-12" 150 psi @ 73°F (23°C)

868V-247C	2X1/2	3/4	1	10	096	77.12
868V-248C	2X3/4	7/8	1	10	096	77.12
868V-249C	2X1	1-1/8	1	10	096	77.12
868V-250C	2X1-1/4	1-1/2	1	10	096	77.12
868V-251C	2X1-1/2	1-1/2	1	10	096	77.12
868V-291C	2-1/2X1-1/2	1-3/4	1	10	096	94.31
868V-333C ¹	3X1/2	7/8	1	10	096	94.31
868V-334C	3X3/4	7/8	1	10	096	94.31

Schedule 80 CPVC Industrial Products & Accessories
Clamp-On & Hot-Tap Saddles



Part Number	Size	Hole Saw Dia	Std Pk	Mstr Ctn	Disc Code	Price Each
-------------	------	--------------	--------	----------	-----------	------------

CPVC Gray Clamp-On Saddle x Soc Double Outlet
 (continued)
 with FKM O-ring Seal & Zinc-Plated Hardware

868V-335C	3X1	1-1/8	1	10	096	94.31
868V-336C ¹	3X1-1/4	2-1/4	1	10	096	94.31
868V-337C ¹	3X1-1/2	2-1/4	1	10	096	94.31
868V-338C ¹	3X2	2-1/4	1	10	096	94.31
868V-415C ¹	4X1/2	1-1/8	1	10	096	126.97
868V-416C ¹	4X3/4	1-1/8	1	10	096	126.97
868V-417C	4X1	1-1/8	1	8	096	126.97
868V-418C ¹	4X1-1/4	1-3/4	1	8	096	126.97
868V-419C	4X1-1/2	1-3/4	1	8	096	126.97
868V-420C	4X2	2-1/4	1	8	096	126.97
868V-421C ¹	4X2-1/2	3	1	4	096	132.66
868V-422C	4X3	3	4	0	096	144.78
868V-523C ¹	6X1/2	1-1/8	1	4	096	205.42
868V-524C ¹	6X3/4	1-1/8	1	4	096	205.42
868V-525C	6X1	1-1/8	1	4	096	205.42
868V-526C ¹	6X1-1/4	2-1/4	1	4	096	205.42
868V-527C ¹	6X1-1/2	2-1/4	1	4	096	205.42
868V-528C	6X2	2-1/4	1	4	096	205.42
868V-529C	6X2-1/2	3	1	4	096	237.92
868V-530C	6X3	3	1	4	096	250.85
868V-532C	6X4	4	1	4	096	261.71
868V-573C ¹	8X1/2	4	1	0	096	397.71
868V-574C ¹	8X3/4	4	1	0	096	397.71
868V-575C ¹	8X1	4	1	0	096	397.71
868V-576C ¹	8X1-1/4	4	1	0	096	397.71
868V-577C ¹	8X1-1/2	4	1	0	096	397.71
868V-578C ¹	8X2	4	1	0	096	397.71
868V-579C ¹	8X2-1/2	4	1	0	096	437.44
868V-580C ¹	8X3	4	1	0	096	459.28
868V-582C	8X4	4	1	0	096	486.80
868V-585C	8X6	6	1	0	096	540.39
868V-624C	10X4	4	1	0	096	642.99
868V-626C	10X6	6	1	0	096	739.67
868V-664C	12X4	4	1	0	096	806.07
868V-666C	12X6	6	1	0	096	934.91

¹Outlet-sized with Bushing

CPVC Gray Clamp-On Saddle x Soc Double Outlet

with FKM O-ring Seal & SS Hardware

2"- 4" 235, 6" 200, 8"-12" 150 psi @ 73°F (23°C)



868SV-247C	2X1/2	3/4	1	10	096	117.68
868SV-248C	2X3/4	7/8	1	10	096	117.68
868SV-249C	2X1	1-1/8	1	10	096	117.68
868SV-250C	2X1-1/4	1-1/2	1	10	096	117.68
868SV-251C	2X1-1/2	1-1/2	1	10	096	117.68
868SV-291C	2-1/2X1-1/2	1-3/4	1	10	096	156.56
868SV-333C ¹	3X1/2	7/8	1	10	096	156.56
868SV-334C	3X3/4	7/8	1	10	096	156.56
868SV-335C	3X1	1-1/8	1	10	096	156.56
868SV-336C ¹	3X1-1/4	2-1/4	1	10	096	156.56
868SV-337C ¹	3X1-1/2	2-1/4	1	10	096	156.56
868SV-338C	3X2	2-1/4	1	10	096	156.56
868SV-415C ¹	4X1/2	1-1/8	1	10	096	198.96
868SV-416C ¹	4X3/4	1-1/8	1	10	096	198.96
868SV-417C	4X1	1-1/8	1	8	096	198.96
868SV-418C ¹	4X1-1/4	1-3/4	1	8	096	198.96
868SV-419C	4X1-1/2	1-3/4	1	8	096	198.96
868SV-420C	4X2	2-1/4	1	8	096	198.96
868SV-421C ¹	4X2-1/2	3	1	4	096	207.01
868SV-422C	4X3	3	4	0	096	220.53
868SV-523C ¹	6X1/2	1-1/8	1	4	096	330.94
868SV-524C ¹	6X3/4	1-1/8	1	4	096	330.94
868SV-525C	6X1	1-1/8	1	4	096	330.94

Part Number	Size	Hole Saw Dia	Std Pk	Mstr Ctn	Disc Code	Price Each
-------------	------	--------------	--------	----------	-----------	------------

CPVC Gray Clamp-On Saddle x Soc Double Outlet
 (continued)
 with FKM O-ring Seal & SS Hardware

868SV-526C ¹	6X1-1/4	2-1/4	1	4	096	330.94
868SV-527C ¹	6X1-1/2	2-1/4	1	4	096	330.94
868SV-528C	6X2	2-1/4	1	4	096	330.94
868SV-529C ¹	6X2-1/2	3	1	4	096	341.12
868SV-530C	6X3	3	1	4	096	356.87
868SV-532C	6X4	4	1	4	096	365.36
868SV-573C ¹	8X1/2	4	1	0	096	558.61
868SV-574C ¹	8X3/4	4	1	0	096	558.61
868SV-575C ¹	8X1	4	1	0	096	558.61
868SV-576C ¹	8X1-1/4	4	1	0	096	558.61
868SV-577C ¹	8X1-1/2	4	1	0	096	558.61
868SV-578C ¹	8X2	4	1	0	096	558.61
868SV-579C ¹	8X2-1/2	4	1	0	096	614.26
868SV-580C ¹	8X3	4	1	0	096	645.14
868SV-582C	8X4	4	1	0	096	683.79
868SV-585C	8X6	6	1	0	096	759.11
868SV-624C	10X4	4	1	0	096	903.35
868SV-626C	10X6	6	1	0	096	1038.97
868SV-664C	12X4	4	1	0	096	1132.21
868SV-666C	12X6	6	1	0	096	1313.51

¹Outlet-sized with Bushing

CPVC Gray Clamp-On Saddle x Soc Double Outlet

with EPDM O-ring Seal & Zinc-Plated Hardware

2"- 4" 235, 6" 200, 8"-12" 150 psi @ 73°F (23°C)



868-247C	2X1/2	3/4	1	10	096	64.69
868-248C	2X3/4	7/8	1	10	096	64.69
868-249C	2X1	1-1/8	1	10	096	64.69
868-250C	2X1-1/4	1-1/2	1	10	096	64.69
868-251C	2X1-1/2	1-1/2	1	10	096	64.69
868-291C	2-1/2X1-1/2	1-3/4	1	10	096	88.82
868-333C ¹	3X1/2	7/8	1	10	096	88.82
868-334C	3X3/4	7/8	1	10	096	88.82
868-335C	3X1	1-1/8	1	10	096	88.82
868-336C ¹	3X1-1/4	2-1/4	1	10	096	88.82
868-337C ¹	3X1-1/2	2-1/4	1	10	096	88.82
868-338C	3X2	2-1/4	1	10	096	88.82
868-415C ¹	4X1/2	1-1/8	1	10	096	111.47
868-416C ¹	4X3/4	1-1/8	1	10	096	111.47
868-417C	4X1	1-1/8	1	8	096	111.47
868-418C ¹	4X1-1/4	1-3/4	1	8	096	111.47
868-419C	4X1-1/2	1-3/4	1	8	096	111.47
868-420C	4X2	2-1/4	1	8	096	111.47
868-421C ¹	4X2-1/2	3	1	4	096	117.38
868-422C	4X3	3	1	4	096	127.59
868-523C ¹	6X1/2	1-1/8	1	4	096	186.11
868-524C ¹	6X3/4	1-1/8	1	4	096	186.11
868-525C	6X1	1-1/8	1	4	096	186.11
868-526C ¹	6X1-1/4	2-1/4	1	4	096	186.11
868-527C ¹	6X1-1/2	2-1/4	1	4	096	186.11
868-528C	6X2	2-1/4	1	4	096	186.11
868-529C ¹	6X2-1/2	3	1	4	096	197.85
868-530C	6X3	3	1	4	096	209.16
868-532C	6X4	4	1	4	096	215.91
868-573C ¹	8X1/2	4	1	0	096	372.93
868-574C ¹	8X3/4	4	1	0	096	372.93
868-575C ¹	8X1	4	1	0	096	372.93
868-576C ¹	8X1-1/4	4	1	0	096	372.93
868-577C ¹	8X1-1/2	4	1	0	096	372.93
868-578C ¹	8X2	4	1	0	096	372.93
868-579C ¹	8X2-1/2	4	1	0	096	410.17
868-580C ¹	8X3	4	1	0	096	430.73
868-582C	8X4	4	1	0	096	456.53



Schedule 80 CPVC Industrial Products & Accessories
Clamp-On & Hot-Tap Saddles

Part Number	Size	Hole Saw Dia	Std Pk	Mstr Ctn	Disc Code	Price Each
-------------	------	--------------	--------	----------	-----------	------------

CPVC Gray Clamp-On Saddle x Soc Double Outlet

(continued)

with EPDM O-ring Seal & Zinc-Plated Hardware

868-585C	8X6	6	1	0	096	506.75
868-624C	10X4	4	1	0	096	603.08
868-626C	10X6	6	1	0	096	693.48
868-664C	12X4	4	1	0	096	755.84
868-666C	12X6	6	1	0	096	876.94

¹Outlet-sized with Bushing

CPVC Gray Clamp-On Saddle x Soc Double Outlet

with EPDM O-ring Seal & SS Hardware

2"- 4" 235, 6" 200, 8"-12" 150 psi @ 73°F (23°C)

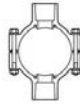

868S-247C	2X1/2	3/4	1	10	096	102.31
868S-248C	2X3/4	7/8	1	10	096	102.31
868S-249C	2X1	1-1/8	1	10	096	102.31
868S-250C	2X1-1/4	1-1/2	1	10	096	102.31
868S-251C	2X1-1/2	1-1/2	1	10	096	102.31
868S-291C	2-1/2X1-1/2	1-3/4	1	10	096	136.07
868S-333C ¹	3X1/2	7/8	1	10	096	136.07
868S-334C	3X3/4	7/8	1	10	096	136.07
868S-335C	3X1	1-1/8	1	10	096	136.07
868S-336C ¹	3X1-1/4	2-1/4	1	10	096	136.07
868S-337C ¹	3X1-1/2	2-1/4	1	10	096	136.07
868S-338C	3X2	2-1/4	1	10	096	136.07
868S-415C ¹	4X1/2	1-1/8	1	10	096	174.37
868S-416C ¹	4X3/4	1-1/8	1	10	096	174.37
868S-417C	4X1	1-1/8	1	8	096	174.37
868S-418C ¹	4X1-1/4	1-3/4	1	8	096	174.37
868S-419C	4X1-1/2	1-3/4	1	8	096	174.37
868S-420C	4X2	2-1/4	1	8	096	174.37
868S-421C ¹	4X2-1/2	3	1	4	096	182.49
868S-422C	4X3	3	4	0	096	190.85
868S-523C ¹	6X1/2	1-1/8	1	4	096	291.20
868S-524C ¹	6X3/4	1-1/8	1	4	096	291.20
868S-525C	6X1	1-1/8	1	4	096	291.20
868S-526C ¹	6X1-1/4	2-1/4	1	4	096	291.20
868S-527C ¹	6X1-1/2	2-1/4	1	4	096	291.20
868S-528C	6X2	2-1/4	1	4	096	291.20
868S-529C ¹	6X2-1/2	3	1	4	096	305.64
868S-530C	6X3	3	1	4	096	313.02
868S-532C	6X4	4	1	4	096	324.42
868S-573C ¹	8X1/2	4	1	0	096	507.62
868S-574C ¹	8X3/4	4	1	0	096	507.62
868S-575C ¹	8X1	4	1	0	096	507.62
868S-576C ¹	8X1-1/4	4	1	0	096	507.62
868S-577C ¹	8X1-1/2	4	1	0	096	507.62
868S-578C ¹	8X2	4	1	0	096	507.62
868S-579C ¹	8X2-1/2	4	1	0	096	558.37
868S-580C ¹	8X3	4	1	0	096	586.31
868S-582C	8X4	4	1	0	096	621.48
868S-585C	8X6	6	1	0	096	689.98
868S-624C	10X4	4	1	0	096	821.03
868S-626C	10X6	6	1	0	096	944.20
868S-664C	12X4	4	1	0	096	1029.17
868S-666C	12X6	6	1	0	096	1193.79

¹Outlet-sized with Bushing

CPVC Gray Clamp-On Saddle x SR Thread Double Outlet

with FKM O-ring Seal & Zinc-Plated Hardware

2"- 4" 235, 6" 200, 8"-12" 150 psi @ 73°F (23°C)



869V-247CSR	2X1/2	3/4	1	10	096	86.27
869V-248CSR	2X3/4	7/8	1	10	096	86.27
869V-249CSR	2X1	1-1/8	1	10	096	86.27
869V-250CSR	2X1-1/4	1-1/2	1	10	096	86.27

Part Number	Size	Hole Saw Dia	Std Pk	Mstr Ctn	Disc Code	Price Each
-------------	------	--------------	--------	----------	-----------	------------

CPVC Gray Clamp-On Saddle x SR Thread Double Outlet (continued)

(continued)

with FKM O-ring Seal & Zinc-Plated Hardware

869V-251CSR	2X1-1/2	1-1/2	1	10	096	86.27
869V-291CSR	2-1/2X1-1/2	1-3/4	1	10	096	118.29
869V-333CSR ¹	3X1/2	7/8	1	10	096	118.29
869V-334CSR	3X3/4	7/8	1	10	096	118.29
869V-335CSR	3X1	1-1/8	1	10	096	118.29
869V-336CSR ¹	3X1-1/4	2-1/4	1	10	096	118.29
869V-337CSR ¹	3X1-1/2	2-1/4	1	10	096	118.29
869V-338CSR	3X2	2-1/4	1	10	096	118.29
869V-415CSR ¹	4X1/2	1-1/8	1	10	096	144.77
869V-416CSR ¹	4X3/4	1-1/8	1	10	096	144.77
869V-417CSR	4X1	1-1/8	1	8	096	144.77
869V-418CSR ¹	4X1-1/4	1-3/4	1	8	096	144.77
869V-419CSR	4X1-1/2	1-3/4	1	8	096	144.77
869V-420CSR	4X2	2-1/4	1	8	096	144.77
869V-421CSR ¹	4X2-1/2	3	1	4	096	155.48
869V-422CSR	4X3	3	4	0	096	163.75
869V-523CSR ¹	6X1/2	1-1/8	1	4	096	240.05
869V-524CSR ¹	6X3/4	1-1/8	1	4	096	240.05
869V-525CSR	6X1	1-1/8	1	4	096	240.05
869V-526CSR ¹	6X1-1/4	2-1/4	1	4	096	240.05
869V-527CSR ¹	6X1-1/2	2-1/4	1	4	096	240.05
869V-528CSR	6X2	2-1/4	1	4	096	240.05
869V-529CSR ¹	6X2-1/2	3	1	4	096	252.13
869V-530CSR	6X3	3	1	4	096	262.54
869V-532CSR	6X4	4	1	4	096	278.09
869V-573CSR ¹	8X1/2	4	1	0	096	442.09
869V-574CSR ¹	8X3/4	4	1	0	096	442.09
869V-575CSR ¹	8X1	4	1	0	096	442.09
869V-576CSR ¹	8X1-1/4	4	1	0	096	442.09
869V-577CSR ¹	8X1-1/2	4	1	0	096	442.09
869V-578CSR ¹	8X2	4	1	0	096	442.09
869V-579CSR ¹	8X2-1/2	4	1	0	096	486.29
869V-580CSR ¹	8X3	4	1	0	096	510.56
869V-582CSR	8X4	4	1	0	096	541.18
869V-585CSR	8X6	6	1	0	096	598.60
869V-624CSR	10X4	4	1	0	096	643.86
869V-626CSR	10X6	6	1	0	096	740.54
869V-664CSR	12X4	4	1	0	096	807.25
869V-666CSR	12X6	6	1	0	096	936.28

¹Outlet-sized with Bushing

CPVC Gray Clamp-On Saddle x SR Thread Double Outlet

with FKM O-ring Seal & SS Hardware

2"- 4" 235, 6" 200, 8"-12" 150 psi @ 73°F (23°C)



869SV-247CSR	2X1/2	3/4	1	10	096	126.97
869SV-248CSR	2X3/4	7/8	1	10	096	126.97
869SV-249CSR	2X1	1-1/8	1	10	096	126.97
869SV-250CSR	2X1-1/4	1-1/2	1	10	096	126.97
869SV-251CSR	2X1-1/2	1-1/2	1	10	096	126.97
869SV-291CSR	2-1/2X1-1/2	1-1/2	1	10	096	160.91
869SV-333CSR ¹	3X1/2	7/8	1	10	096	160.91
869SV-334CSR	3X3/4	7/8	1	10	096	160.91
869SV-335CSR	3X1	1-1/8	1	10	096	160.91
869SV-336CSR ¹	3X1-1/4	2-1/4	1	10	096	160.91
869SV-337CSR ¹	3X1-1/2	2-1/4	1	10	096	160.91
869SV-338CSR	3X2	2-1/4	1	10	096	160.91
869SV-415CSR ¹	4X1/2	1-1/8	1	10	096	211.29
869SV-416CSR ¹	4X3/4	1-1/8	1	10	096	211.29
869SV-417CSR	4X1	1-1/8	1	8	096	211.29
869SV-418CSR ¹	4X1-1/4	1-3/4	1	8	096	211.29
869SV-419CSR	4X1-1/2	1-3/4	1	8	096	211.29
869SV-420CSR	4X2	2-1/4	1	8	096	211.29
869SV-421CSR ¹	4X2-1/2	3	1	4	096	221.83

Schedule 80 CPVC Industrial Products & Accessories
Clamp-On & Hot-Tap Saddles



Part Number	Size	Hole Saw Dia	Std Pk	Mstr Ctn	Disc Code	Price Each
-------------	------	--------------	--------	----------	-----------	------------

CPVC Gray Clamp-On Saddle x SR Thread Double Outlet (continued)

with FKM O-ring Seal & SS Hardware

869SV-422CSR	4X3	3	4	0	096	237.65
869SV-523CSR ¹	6X1/2	1-1/8	1	4	096	377.55
869SV-524CSR ¹	6X3/4	1-1/8	1	4	096	377.55
869SV-525CSR	6X1	1-1/8	1	4	096	377.55
869SV-526CSR ¹	6X1-1/4	2-1/4	1	4	096	377.55
869SV-527CSR ¹	6X1-1/2	2-1/4	1	4	096	377.55
869SV-528CSR	6X2	2-1/4	1	4	096	377.55
869SV-529CSR ¹	6X2-1/2	3	1	4	096	392.06
869SV-530CSR	6X3	3	1	4	096	404.49
869SV-532CSR	6X4	4	1	4	096	413.76
869SV-573CSR ¹	8X1/2	4	1	0	096	618.39
869SV-574CSR ¹	8X3/4	4	1	0	096	618.39
869SV-575CSR ¹	8X1	4	1	0	096	618.39
869SV-576CSR ¹	8X1-1/4	4	1	0	096	618.39
869SV-577CSR ¹	8X1-1/2	4	1	0	096	618.39
869SV-578CSR ¹	8X2	4	1	0	096	618.39
869SV-579CSR ¹	8X2-1/2	4	1	0	096	680.14
869SV-580CSR ¹	8X3	4	1	0	096	701.67
869SV-582CSR	8X4	4	1	0	096	757.04
869SV-585CSR	8X6	6	1	0	096	808.81
869SV-624CSR	10X4	4	1	0	096	900.86
869SV-626CSR	10X6	6	1	0	096	1036.04
869SV-664CSR	12X4	4	1	0	096	1129.27
869SV-666CSR	12X6	6	1	0	096	1310.06

¹Outlet-sized with Bushing

CPVC Gray Clamp-On Saddle x SR Thread Double Outlet

with EPDM O-ring Seal & Zinc-Plated Hardware

2"- 4" 235, 6" 200, 8"-12" 150 psi @ 73°F (23°C)



869-247CSR	2X1/2	3/4	1	10	096	74.96
869-248CSR	2X3/4	7/8	1	10	096	74.96
869-249CSR	2X1	1-1/8	1	10	096	74.96
869-250CSR	2X1-1/4	1-1/2	1	10	096	74.96
869-251CSR	2X1-1/2	1-1/2	1	10	096	74.96
869-291CSR	2-1/2X1-1/2	1-3/4	1	10	096	101.22
869-333CSR ¹	3X1/2	7/8	1	10	096	101.22
869-334CSR	3X3/4	7/8	1	10	096	101.22
869-335CSR	3X1	1-1/8	1	10	096	101.22
869-336CSR ¹	3X1-1/4	1-1/8	1	10	096	101.22
869-337CSR ¹	3X1-1/2	2-1/4	1	10	096	101.22
869-338CSR	3X2	2-1/4	1	10	096	101.22
869-415CSR ¹	4X1/2	1-1/8	1	10	096	125.65
869-416CSR ¹	4X3/4	1-1/8	1	10	096	125.65
869-417CSR	4X1	1-1/8	1	8	096	125.65
869-418CSR ¹	4X1-1/4	1-3/4	1	8	096	125.65
869-419CSR	4X1-1/2	1-3/4	1	8	096	125.65
869-420CSR	4X2	2-1/4	1	8	096	125.65
869-421CSR ¹	4X2-1/2	3	1	4	096	138.96
869-422CSR	4X3	3	1	4	096	150.38
869-523CSR ¹	6X1/2	1-1/8	1	4	096	205.25
869-524CSR ¹	6X3/4	1-1/8	1	4	096	205.25
869-525CSR	6X1	1-1/8	1	4	096	205.25
869-526CSR ¹	6X1-1/4	2-1/4	1	4	096	205.25
869-527CSR ¹	6X1-1/2	2-1/4	1	4	096	205.25
869-528CSR	6X2	2-1/4	1	4	096	205.25
869-529CSR ¹	6X2-1/2	3	1	4	096	219.69
869-530CSR	6X3	3	1	4	096	237.69
869-532CSR	6X4	4	1	4	096	252.07
869-573CSR ¹	8X1/2	4	1	0	096	397.37
869-574CSR ¹	8X3/4	4	1	0	096	397.37
869-575CSR ¹	8X1	4	1	0	096	397.37
869-576CSR ¹	8X1-1/4	4	1	0	096	397.37
869-577CSR ¹	8X1-1/2	4	1	0	096	397.37

Part Number	Size	Hole Saw Dia	Std Pk	Mstr Ctn	Disc Code	Price Each
-------------	------	--------------	--------	----------	-----------	------------

CPVC Gray Clamp-On Saddle x SR Thread Double Outlet (continued)

with EPDM O-ring Seal & Zinc-Plated Hardware

869-578CSR ¹	8X2	4	1	0	096	397.37
869-579CSR ¹	8X2-1/2	4	1	0	096	437.18
869-580CSR ¹	8X3	4	1	0	096	459.13
869-582CSR	8X4	4	1	0	096	486.62
869-585CSR	8X6	6	1	0	096	525.81
869-624CSR	10X4	4	1	0	096	578.99
869-626CSR	10X6	6	1	0	096	665.96
869-664CSR	12X4	4	1	0	096	725.91
869-666CSR	12X6	6	1	0	096	842.03

¹Outlet-sized with Bushing

CPVC Gray Clamp-On Saddle x SR Thread Double Outlet

with EPDM O-ring Seal & SS Hardware

2"- 4" 235, 6" 200, 8"-12" 150 psi @ 73°F (23°C)

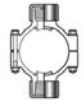

869S-247CSR	2X1/2	3/4	1	10	096	120.48
869S-248CSR	2X3/4	7/8	1	10	096	120.48
869S-249CSR	2X1	1-1/8	1	10	096	120.48
869S-250CSR	2X1-1/4	1-1/2	1	10	096	120.48
869S-251CSR	2X1-1/2	1-1/2	1	10	096	120.48
869S-291CSR	2-1/2X1-1/2	1-3/4	1	10	096	158.89
869S-333CSR ¹	3X1/2	7/8	1	10	096	158.89
869S-334CSR	3X3/4	7/8	1	10	096	158.89
869S-335CSR	3X1	1-1/8	1	10	096	158.89
869S-336CSR ¹	3X1-1/4	2-1/4	1	10	096	158.89
869S-337CSR ¹	3X1-1/2	2-1/4	1	10	096	158.89
869S-338CSR	3X2	2-1/4	1	10	096	158.89
869S-415CSR ¹	4X1/2	1-1/8	1	10	096	198.95
869S-416CSR ¹	4X3/4	1-1/8	1	10	096	198.95
869S-417CSR	4X1	1-1/8	1	8	096	198.95
869S-418CSR ¹	4X1-1/4	1-3/4	1	8	096	198.95
869S-419CSR	4X1-1/2	1-3/4	1	8	096	198.95
869S-420CSR	4X2	2-1/4	1	8	096	198.95
869S-421CSR ¹	4X2-1/2	3	1	4	096	213.72
869S-422CSR	4X3	3	4	0	096	229.08
869S-523CSR ¹	6X1/2	1-1/8	1	4	096	335.07
869S-524CSR ¹	6X3/4	1-1/8	1	4	096	335.07
869S-525CSR	6X1	1-1/8	1	4	096	335.07
869S-526CSR ¹	6X1-1/4	2-1/4	1	4	096	335.07
869S-527CSR ¹	6X1-1/2	2-1/4	1	4	096	335.07
869S-528CSR	6X2	2-1/4	1	4	096	335.07
869S-529CSR ¹	6X2-1/2	3	1	4	096	342.60
869S-530CSR	6X3	3	1	4	096	357.74
869S-532CSR	6X4	4	1	4	096	367.73
869S-573CSR ¹	8X1/2	4	1	0	096	563.97
869S-574CSR ¹	8X3/4	4	1	0	096	563.97
869S-575CSR ¹	8X1	4	1	0	096	563.97
869S-576CSR ¹	8X1-1/4	4	1	0	096	563.97
869S-577CSR ¹	8X1-1/2	4	1	0	096	563.97
869S-578CSR ¹	8X2	4	1	0	096	563.97
869S-579CSR ¹	8X2-1/2	4	1	0	096	620.31
869S-580CSR ¹	8X3	4	1	0	096	651.25
869S-582CSR	8X4	4	1	0	096	690.38
869S-585CSR	8X6	6	1	0	096	725.01
869S-624CSR	10X4	4	1	0	096	821.56
869S-626CSR	10X6	6	1	0	096	944.72
869S-664CSR	12X4	4	1	0	096	1029.85
869S-666CSR	12X6	6	1	0	096	1194.49

¹Outlet-sized with Bushing



Schedule 80 CPVC Industrial Products & Accessories
Clamp-On & Hot-Tap Saddles & Glue-on Saddles

Clamp-On & Hot-Tap Saddles

Part Number	Size	Std Pk	Mstr Ctn	Disc Code	Price Each
-------------	------	--------	----------	-----------	------------

CPVC Gray Hot-Tap Saddle
EPDM Saddle x Soc (Spigot) Zinc Plated Bolts



2"- 4" 235, 6" 200, 8" 150 psi @ 73°F (23°C)

HT2-248C	2X3/4 (1)	1	5	050	85.15
HT2-251C	2X1-1/2 (2)	1	5	050	175.76
HT2-288C	2-1/2X3/4 (1)	1	5	050	90.89
HT2-291C	2-1/2X1-1/2 (2)	1	5	050	181.63
HT2-334C	3X3/4 (1)	1	5	050	104.14
HT2-337C	3X1-1/2 (2)	1	5	050	200.31
HT2-416C	4X3/4 (1)	1	5	050	120.32
HT2-419C	4X1-1/2 (2)	1	0	050	211.79
HT2-524C	6X3/4 (1)	1	5	050	135.31
HT2-527C	6X1-1/2 (2)	1	0	050	225.46
HT2-574C	8X3/4 (1)	1	5	050	124.62
HT2-577C	8X1-1/2 (2)	1	0	050	232.81

CPVC Gray Hot-Tap Saddle
EPDM Saddle x Soc (Spigot) SS316 Bolts



2"- 4" 235, 6" 200, 8" 150 psi @ 73°F (23°C)

HT2S-248C	2X3/4 (1)	1	5	050	132.36
HT2S-251C	2X1-1/2 (2)	1	5	050	273.56
HT2S-288C	2-1/2X3/4 (1)	1	5	050	141.48
HT2S-291C	2-1/2X1-1/2 (2)	1	5	050	282.82
HT2S-334C	3X3/4 (1)	1	5	050	162.23
HT2S-337C	3X1-1/2 (2)	1	5	050	311.80
HT2S-416C	4X3/4 (1)	1	5	050	187.38
HT2S-419C	4X1-1/2 (2)	1	0	050	329.75
HT2S-524C	6X3/4 (1)	1	5	050	210.32
HT2S-527C	6X1-1/2 (2)	1	0	050	350.92
HT2S-574C	8X3/4 (1)	1	0	050	227.38
HT2S-577C	8X1-1/2 (2)	1	0	050	379.45

CPVC Gray Hot-Tap Saddle
FKM Saddle x Soc (Spigot) Zinc Plated Bolts



2"- 4" 235, 6" 200, 8" 150 psi @ 73°F (23°C)

HT3-248C	2X3/4 (1)	1	5	050	92.52
HT3-251C	2X1-1/2 (2)	1	5	050	190.75
HT3-288C	2-1/2X3/4 (1)	1	5	050	98.84
HT3-291C	2-1/2X1-1/2 (2)	1	5	050	197.07
HT3-334C	3X3/4 (1)	1	5	050	112.95
HT3-337C	3X1-1/2 (2)	1	5	050	217.66
HT3-416C	4X3/4 (1)	1	5	050	203.26
HT3-419C	4X1-1/2 (2)	1	0	050	230.02
HT3-524C	6X3/4 (1)	1	5	050	146.92
HT3-527C	6X1-1/2 (2)	1	0	050	244.14
HT3-574C	8X3/4 (1)	1	0	050	158.83
HT3-577C	8X1-1/2 (2)	1	0	050	295.93

Part Number	Size	Std Pk	Mstr Ctn	Disc Code	Price Each
-------------	------	--------	----------	-----------	------------

CPVC Gray Hot-Tap Saddle
FKM Saddle x Soc (Spigot) SS316 Bolts



2"- 4" 235, 6" 200, 8" 150 psi @ 73°F (23°C)

HT3S-248C	2X3/4 (1)	1	5	050	144.14
HT3S-251C	2X1-1/2 (2)	1	5	050	297.08
HT3S-288C	2-1/2X3/4 (1)	1	5	050	153.83
HT3S-291C	2-1/2X1-1/2 (2)	1	5	050	306.65
HT3S-334C	3X3/4 (1)	1	5	050	175.61
HT3S-337C	3X1-1/2 (2)	1	5	050	345.04
HT3S-416C	4X3/4 (1)	1	5	050	203.26
HT3S-419C	4X1-1/2 (2)	1	0	050	358.13
HT3S-524C	6X3/4 (1)	1	5	050	228.71
HT3S-527C	6X1-1/2 (2)	1	0	050	380.03
HT3S-574C	8X3/4 (1)	1	0	050	247.23
HT3S-577C	8X1-1/2 (2)	1	5	050	410.85

CPVC Gray Hot-Tap Saddle
EPDM with Stainless Steel Cutter & Bolts



2"- 4" 235, 6" 200, 8" 150 psi @ 73°F (23°C)

HTS2S-248C	2X3/4 (1)	1	5	050	407.25
HTS2S-251C	2X1-1/2 (2)	1	5	050	603.55
HTS2S-288C	2-1/2X3/4 (1)	1	5	050	435.76
HTS2S-291C	2-1/2X1-1/2 (2)	1	5	050	604.52
HTS2S-334C	3X3/4 (1)	1	5	050	415.62
HTS2S-337C	3X1-1/2 (2)	1	5	050	621.38
HTS2S-416C	4X3/4 (1)	1	5	050	442.54
HTS2S-419C	4X1-1/2 (2)	1	0	050	636.83
HTS2S-524C	6X3/4 (1)	1	5	050	515.85
HTS2S-527C	6X1-1/2 (2)	1	0	050	719.88
HTS2S-574C	8X3/4 (1)	1	0	050	715.60
HTS2S-577C	8X1-1/2 (2)	1	0	050	852.33

CPVC Gray Hot-Tap Saddle
FKM with Stainless Steel Cutter & Bolts



2"- 4" 235, 6" 200, 8" 150 psi @ 73°F (23°C)

HTS3S-248C	2X3/4 (1)	1	5	050	413.63
HTS3S-251C	2X1-1/2 (2)	1	5	050	612.74
HTS3S-288C	2-1/2X3/4 (1)	1	5	050	442.68
HTS3S-291C	2-1/2X1-1/2 (2)	1	5	050	615.15
HTS3S-334C	3X3/4 (1)	1	5	050	380.64
HTS3S-337C	3X1-1/2 (2)	1	5	050	632.17
HTS3S-416C	4X3/4 (1)	1	5	050	450.88
HTS3S-419C	4X1-1/2 (2)	1	0	050	652.81
HTS3S-524C	6X3/4 (1)	1	5	050	523.92
HTS3S-527C	6X1-1/2 (2)	1	0	050	735.84
HTS3S-574C	8X3/4 (1)	1	0	050	731.43
HTS3S-577C	8X1-1/2 (2)	1	0	050	859.96

Glue-on Saddles

Part Number	Size	Std Pk	Mstr Ctn	Disc Code	Price Each
-------------	------	--------	----------	-----------	------------

Saddle
IPS O.D. x Socket Schedule 80



Non Pressure Rated

3963-528C	6X2	1	5	099	96.52
3963-530C	6X3	1	5	099	109.35
3963-532C	6X4	1	10	099	133.83
3963-578C	8X2	1	5	099	146.48

Part Number	Size	Std Pk	Mstr Ctn	Disc Code	Price Each
-------------	------	--------	----------	-----------	------------

Saddle (continued)
IPS O.D. x Socket Schedule 80

3963-580C	8X3	1	8	099	162.61
3963-582C	8X4	1	5	099	209.04
3963-585C	8X6	1	0	099	239.28
3963-621C	10X2	1	5	099	163.84
3963-623C	10X3	1	8	099	180.42
3963-624C	10X4	1	5	099	221.59

Schedule 80 CPVC Industrial Products & Accessories
Glue-on Saddles



Part Number	Size	Std Pk	Mstr Ctn	Disc Code	Price Each
-------------	------	--------	----------	-----------	------------

Saddle (continued)

IPS O.D. x Socket Schedule 80

3963-626C	10X6	1	5	099	271.57
3963-628C	10X8	1	5	099	300.38
3963-661C	12X2	1	10	099	180.34
3963-663C	12X3	1	8	099	210.61
3963-664C	12X4	1	8	099	252.14
3963-666C	12X6	1	0	099	292.33
3963-668C	12X8	1	4	099	368.58
3963-670C	12X10	1	0	099	576.45
3963-693C	14X3	1	8	099	226.63
3963-694C	14X4	1	5	099	293.46
3963-696C	14X6	1	10	099	342.97
3963-698C	14X8	1	4	099	408.45
3963-700C	14X10	1	3	099	717.76
3963-702C	14X12	1	4	099	841.72
3963-751C	16X2	1	5	099	217.93
3963-753C	16X3	1	8	099	272.94
3963-754C	16X4	1	10	099	342.56
3963-756C	16X6	1	3	099	464.24
3963-758C	16X8	1	3	099	582.65
3963-760C	16X10	1	0	099	800.91
3963-762C	16X12	1	0	099	1122.84
3963-764C	16X14	1	0	099	1291.16
3963-781C	18X2	1	5	409	265.43
3963-783C	18X3	1	4	099	298.60
3963-784C	18X4	1	5	099	435.14
3963-786C	18X6	1	5	099	596.49
3963-788C	18X8	1	5	099	673.21
3963-790C	18X10	1	0	099	878.13
3963-792C	18X12	1	0	099	1261.44
3963-794C	18X14	1	0	099	1379.15
3963-796C	18X16	1	0	099	1592.36
3963-811C	20X2	1	0	099	279.52
3963-813C	20X3	1	4	099	323.26
3963-814C	20X4	1	4	099	485.51
3963-816C	20X6	1	0	099	644.74
3963-818C	20X8	1	0	099	794.62
3963-820C	20X10	1	5	099	971.47
3963-822C	20X12	1	0	099	1311.81
3963-824C	20X14	1	0	099	1530.77
3963-826C	20X16	1	0	099	1706.20
3963-828C	20X18	1	0	099	1860.54
3963-901C	24X2	1	5	099	306.38
3963-903C	24X3	1	5	099	511.17
3963-904C	24X4	1	5	099	593.53
3963-906C	24X6	1	5	099	844.41
3963-908C	24X8	1	5	099	992.65
3963-910C	24X10	1	5	099	1228.37
3963-912C	24X12	1	0	099	1392.32
3963-914C	24X14	1	0	099	1626.20
3963-916C	24X16	1	0	099	1799.68
3963-918C	24X18	1	0	099	1993.79
3963-920C	24X20	1	0	099	2374.32

Stub Saddle

IPS O.D. x Socket Schedule 80



Non Pressure Rated

3965-528C	6X2	1	10	099	121.51
3965-530C	6X3	1	3	099	130.54
3965-532C	6X4	1	5	099	162.23
3965-578C	8X2	1	5	099	151.88
3965-580C	8X3	1	4	099	99.66
3965-582C	8X4	1	5	099	225.85
3965-585C	8X6	1	4	099	284.15
3965-621C	10X2	1	6	099	173.63

Part Number	Size	Std Pk	Mstr Ctn	Disc Code	Price Each
-------------	------	--------	----------	-----------	------------

Stub Saddle (continued)

IPS O.D. x Socket Schedule 80

3965-623C	10X3	1	5	099	194.99
3965-624C	10X4	1	4	099	237.05
3965-626C	10X6	1	4	099	183.15
3965-628C	10X8	1	4	099	305.19
3965-661C	12X2	1	2	099	196.68
3965-663C	12X3	1	2	099	232.84
3965-664C	12X4	1	2	099	271.20
3965-666C	12X6	1	2	099	316.22
3965-668C	12X8	1	2	099	405.86
3965-670C	12X10	1	2	099	717.61
3965-691C	14X2	1	10	099	211.73
3965-693C	14X3	1	0	099	259.13
3965-694C	14X4	1	5	099	307.55
3965-696C	14X6	1	2	099	395.87
3965-700C	14X10	1	0	099	799.58
3965-702C	14X12	1	0	099	982.35
3965-751C	16X2	1	5	099	244.96
3965-753C	16X3	1	4	099	279.17
3965-754C	16X4	1	3	099	367.75
3965-756C	16X6	1	2	099	492.93
3965-758C	16X8	1	0	099	621.68
3965-760C	16X10	1	0	099	835.56
3965-762C	16X12	1	0	099	1165.87
3965-764C	16X14	1	0	099	1584.51
3965-781C	18X2	1	2	099	280.42
3965-783C	18X3	1	0	099	311.89
3965-784C	18X4	1	0	099	460.82
3965-786C	18X6	1	2	099	625.34
3965-788C	18X8	1	0	099	688.75
3965-790C	18X10	1	0	099	1002.81
3965-792C	18X12	1	0	099	1953.57
3965-794C	18X14	1	0	099	2508.54
3965-796C	18X16	1	0	099	3213.57
3965-811C	20X2	1	0	099	293.99
3965-813C	20X3	1	2	099	333.03
3965-814C	20X4	1	0	099	503.89
3965-816C	20X6	1	0	099	669.20
3965-818C	20X8	1	0	099	831.65
3965-820C	20X10	1	0	099	1138.05
3965-822C	20X12	1	0	099	2092.63
3965-824C	20X14	1	0	099	2714.15
3965-826C	20X16	1	0	099	3436.73
3965-828C	20X18	1	0	099	4189.82
3965-901C	24X2	1	5	099	324.05
3965-903C	24X3	1	2	099	542.97
3965-904C	24X4	1	5	099	636.11
3965-906C	24X6	1	3	099	897.73
3965-908C	24X8	1	0	099	1051.60
3965-910C	24X10	1	0	099	1317.91
3965-912C	24X12	1	0	099	2259.86
3965-914C	24X14	1	0	099	2856.87
3965-916C	24X16	1	0	099	3504.23
3965-918C	24X18	1	0	099	4273.22
3965-920C	24X20	1	0	099	5508.66



**Schedule 80 CPVC Industrial Products & Accessories
Tank Adapters**

Part Number	Size	Std Pk	Mstr Ctn	Disc Code	Price Each
-------------	------	--------	----------	-----------	------------

CPVC Self Aligning Tank Adapter with Neoprene Gasket

Fipt

75 psi Maximum Internal Pressure Rating @ 73°F (23°C)

8172SA-010C	1	5	0	101	211.31
8172SA-020C	2	4	0	101	318.92
8172SA-030C	3	2	0	101	496.95



CPVC Self Aligning Tank Adapter with EPDM Gasket

Fipt

75 psi Maximum Internal Pressure Rating @ 73°F (23°C)

8172ESA-010C	1	5	0	101	222.15
8172ESA-020C	2	4	0	101	336.43
8172ESA-030C	3	2	0	101	523.27



CPVC Self Aligning Tank Adapter with FKM Gasket

Fipt

75 psi Maximum Internal Pressure Rating @ 73°F (23°C)

8172VSA-010C	1	5	0	101	439.07
8172VSA-020C	2	4	0	101	664.61
8172VSA-030C	3	2	0	101	1032.62

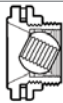

CPVC New Style Standard Tank Adapters with Neoprene Gaskets

Soc

150 psi Maximum Internal Pressure Rating @ 73°F (23°C)

8170-002C	1/4	25	150	101	48.33
8170-003C	3/8	25	150	101	48.33
8170-005C	1/2	25	0	101	48.33
8170-007C	3/4	25	0	101	57.49
8170-010C	1	25	0	101	64.53
8170-012C	1-1/4	20	0	101	82.31
8170-015C	1-1/2	20	0	101	89.62
8170-020C	2	15	0	101	126.52
8170-025C	2-1/2	4	0	101	185.95
8170-030C	3	4	0	101	221.34
8170-040C	4	2	0	101	368.87
8170-060C	6	1	0	101	1014.41
8170-080C	8	1	0	101	2254.08



CPVC New Style Standard Tank Adapters with EPDM Gaskets

Soc

150 psi Maximum Internal Pressure Rating @ 73°F (23°C)

8170E-002C	1/4	25	150	101	54.97
8170E-003C	3/8	25	150	101	54.97
8170E-005C	1/2	25	0	101	54.97
8170E-007C	3/4	25	0	101	61.69
8170E-010C	1	25	0	101	71.64
8170E-012C	1-1/4	20	0	101	90.66
8170E-015C	1-1/2	20	0	101	95.12
8170E-020C	2	15	0	101	137.14
8170E-025C	2-1/2	4	0	101	194.80
8170E-030C	3	4	0	101	231.92
8170E-040C	4	2	0	101	384.98
8170E-060C	6	1	0	101	1056.68
8170E-080C	8	1	0	101	2319.98

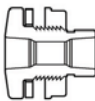

CPVC New Style Standard Tank Adapters with FKM Gaskets

Soc

150 psi Maximum Internal Pressure Rating @ 73°F (23°C)

8170V-002C	1/4	25	150	101	72.08
------------	-----	----	-----	-----	-------



Part Number	Size	Std Pk	Mstr Ctn	Disc Code	Price Each
-------------	------	--------	----------	-----------	------------

CPVC New Style Standard Tank Adapters with FKM Gaskets (continued)

Soc

8170V-003C	3/8	25	150	101	72.08
8170V-005C	1/2	25	0	101	72.08
8170V-007C	3/4	25	0	101	82.92
8170V-010C	1	25	0	101	95.98
8170V-012C	1-1/4	20	0	101	117.93
8170V-015C	1-1/2	20	0	101	122.94
8170V-020C	2	15	0	101	186.12
8170V-025C	2-1/2	4	0	101	267.89
8170V-030C	3	4	0	101	318.92
8170V-040C	4	2	0	101	706.39
8170V-060C	6	1	0	101	1775.27
8170V-080C	8	1	0	101	4152.82

CPVC New Style Standard Tank Adapters with Neoprene Gaskets

Soc x Fipt

150 psi Maximum Internal Pressure Rating @ 73°F (23°C)

8171-002C	1/4	25	150	101	48.33
8171-003C	3/8	25	200	101	48.33
8171-005C	1/2	25	0	101	48.33
8171-007C	3/4	25	0	101	57.49
8171-010C	1	25	0	101	64.53
8171-012C	1-1/4	20	0	101	82.31
8171-015C	1-1/2	20	0	101	89.62
8171-020C	2	15	0	101	126.52
8171-025C	2-1/2	4	0	101	185.95
8171-030C	3	4	0	101	221.34
8171-040C	4	2	0	101	368.87
8171-060C	6	1	0	101	1014.41

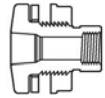

CPVC New Style Standard Tank Adapters with EPDM Gaskets

Soc x Fipt

150 psi Maximum Internal Pressure Rating @ 73°F (23°C)

8171E-002C	1/4	25	150	101	54.97
8171E-003C	3/8	25	200	101	54.97
8171E-005C	1/2	25	0	101	54.97
8171E-007C	3/4	25	0	101	61.69
8171E-010C	1	25	0	101	71.64
8171E-012C	1-1/4	20	0	101	90.66
8171E-015C	1-1/2	20	0	101	95.12
8171E-020C	2	15	0	101	137.14
8171E-025C	2-1/2	4	0	101	194.80
8171E-030C	3	4	0	101	231.92
8171E-040C	4	2	0	101	384.98
8171E-060C	6	1	0	101	1056.67

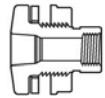

CPVC New Style Standard Tank Adapters with FKM Gaskets

Soc x Fipt

150 psi Maximum Internal Pressure Rating @ 73°F (23°C)

8171V-002C	1/4	25	150	101	72.08
8171V-003C	3/8	25	200	101	72.08
8171V-005C	1/2	25	0	101	72.08
8171V-007C	3/4	25	0	101	82.92
8171V-010C	1	25	0	101	95.98
8171V-012C	1-1/4	20	0	101	117.93
8171V-015C	1-1/2	20	0	101	122.94
8171V-020C	2	15	0	101	186.12
8171V-025C	2-1/2	4	0	101	267.93
8171V-030C	3	4	0	101	318.92
8171V-040C	4	2	0	101	706.39
8171V-060C	6	1	0	101	1775.27

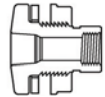

Schedule 80 CPVC Industrial Products & Accessories
Tank Adapters



Part Number	Size	Std Pk	Mstr Ctn	Disc Code	Price Each
-------------	------	--------	----------	-----------	------------

CPVC New Style Special Reinforced (SR) Threaded Tank Adapters with Neoprene Gaskets



Soc x SR Fipt - Stainless Steel Collar

150 psi Maximum Internal Pressure Rating @ 73°F (23°C)

8171-002CSR	1/4	25	150	101	49.80
8171-003CSR	3/8	25	200	101	49.80
8171-005CSR	1/2	25	0	101	49.80
8171-007CSR	3/4	25	0	101	59.60
8171-010CSR	1	25	0	101	67.42
8171-012CSR	1-1/4	20	0	101	86.97
8171-015CSR	1-1/2	20	0	101	97.64
8171-020CSR	2	15	0	101	135.02
8171-025CSR	2-1/2	4	0	101	205.39
8171-030CSR	3	4	0	101	244.46
8171-040CSR	4	2	0	101	392.88
8171-060CSR	6	1	0	101	1037.65

CPVC New Style Special Reinforced (SR) Threaded Tank Adapters with EPDM Gaskets



Soc x SR Fipt - Stainless Steel Collar

150 psi Maximum Internal Pressure Rating @ 73°F (23°C)

8171E-002CSR	1/4	25	150	101	56.44
8171E-003CSR	3/8	25	200	101	56.44
8171E-005CSR	1/2	25	0	101	56.44
8171E-007CSR	3/4	25	0	101	63.79
8171E-010CSR	1	25	0	101	76.27
8171E-012CSR	1-1/4	20	0	101	95.32
8171E-015CSR	1-1/2	20	0	101	103.13
8171E-020CSR	2	15	0	101	145.79
8171E-025CSR	2-1/2	4	0	101	214.24
8171E-030CSR	3	4	0	101	255.05
8171E-040CSR	4	2	0	101	408.93
8171E-060CSR	6	2	0	101	1079.93

CPVC New Style Special Reinforced (SR) Threaded Tank Adapters with FKM Gaskets



Soc x SR Fipt - Stainless Steel Collar

150 psi Maximum Internal Pressure Rating @ 73°F (23°C)

8171V-002CSR	1/4	25	150	101	73.54
8171V-003CSR	3/8	25	200	101	73.54
8171V-005CSR	1/2	25	0	101	73.54
8171V-007CSR	3/4	25	0	101	85.01
8171V-010CSR	1	25	0	101	98.89
8171V-012CSR	1-1/4	20	0	101	122.59
8171V-015CSR	1-1/2	20	0	101	130.91
8171V-020CSR	2	15	0	101	194.93
8171V-025CSR	2-1/2	4	0	101	287.26
8171V-030CSR	3	4	0	101	342.05
8171V-040CSR	4	2	0	101	730.36
8171V-060CSR	6	2	0	101	1803.22

CPVC New Style Standard Tank Adapters with Neoprene Gaskets



Fipt

150 psi Maximum Internal Pressure Rating @ 73°F (23°C)

8172-002C	1/4	25	150	101	64.53
8172-003C	3/8	25	200	101	64.53
8172-005C	1/2	25	0	101	64.53
8172-007C	3/4	25	0	101	74.51
8172-010C	1	25	0	101	81.51
8172-012C	1-1/4	20	0	101	115.07
8172-015C	1-1/2	20	0	101	125.78
8172-020C	2	15	0	101	156.77
8172-025C	2-1/2	4	0	101	220.62
8172-030C	3	4	0	101	262.63

Part Number	Size	Std Pk	Mstr Ctn	Disc Code	Price Each
-------------	------	--------	----------	-----------	------------

CPVC New Style Standard Tank Adapters with Neoprene Gaskets (continued)

Fipt

8172-040C	4	2	0	101	414.96
8172-060C	6	1	0	101	1152.74

CPVC New Style Standard Tank Adapters with EPDM Gaskets

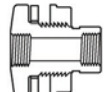

Fipt

150 psi Maximum Internal Pressure Rating @ 73°F (23°C)

8172E-002C	1/4	25	150	101	67.07
8172E-003C	3/8	25	200	101	67.07
8172E-005C	1/2	25	0	101	67.07
8172E-007C	3/4	25	0	101	79.08
8172E-010C	1	25	0	101	85.21
8172E-012C	1-1/4	20	0	101	119.71
8172E-015C	1-1/2	20	0	101	136.61
8172E-020C	2	15	0	101	168.84
8172E-025C	2-1/2	4	0	101	248.22
8172E-030C	3	4	0	101	295.54
8172E-040C	4	2	0	101	492.03
8172E-060C	6	1	0	101	1170.14

CPVC New Style Standard Tank Adapters with FKM Gaskets

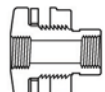

Fipt

150 psi Maximum Internal Pressure Rating @ 73°F (23°C)

8172V-002C	1/4	25	150	101	103.79
8172V-003C	3/8	25	200	101	103.79
8172V-005C	1/2	25	0	101	103.79
8172V-007C	3/4	25	0	101	116.99
8172V-010C	1	25	0	101	134.62
8172V-012C	1-1/4	20	0	101	165.14
8172V-015C	1-1/2	20	0	101	170.87
8172V-020C	2	15	0	101	266.18
8172V-025C	2-1/2	4	0	101	377.73
8172V-030C	3	4	0	101	449.64
8172V-040C	4	2	0	101	1182.45
8172V-060C	6	1	0	101	2167.27

CPVC New Style Special Reinforced (SR) Threaded Tank Adapters with Neoprene Gaskets

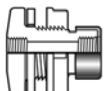

Fipt x SR Fipt - Stainless Steel Collar

150 psi Maximum Internal Pressure Rating @ 73°F (23°C)

8172-002CSR	1/4	25	150	101	65.97
8172-003CSR	3/8	25	200	101	65.97
8172-005CSR	1/2	25	0	101	65.97
8172-007CSR	3/4	25	0	101	76.61
8172-010CSR	1	25	0	101	84.41
8172-012CSR	1-1/4	20	0	101	119.75
8172-015CSR	1-1/2	20	0	101	133.78
8172-020CSR	2	15	0	101	165.40
8172-025CSR	2-1/2	4	0	101	240.05
8172-030CSR	3	4	0	101	285.78
8172-040CSR	4	2	0	101	438.93
8172-060CSR	6	2	0	101	1175.97

CPVC New Style Special Reinforced (SR) Threaded Tank Adapters with EPDM Gaskets

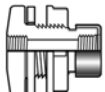

Fipt x SR Fipt - Stainless Steel Collar

150 psi Maximum Internal Pressure Rating @ 73°F (23°C)

8172E-002CSR	1/4	25	150	101	68.55
8172E-003CSR	3/8	25	200	101	68.55
8172E-005CSR	1/2	25	0	101	68.55
8172E-007CSR	3/4	25	0	101	81.17



Schedule 80 CPVC Industrial Products & Accessories
Tank Adapters

Part Number	Size	Std Pk	Mstr Ctn	Disc Code	Price Each
-------------	------	--------	----------	-----------	------------

CPVC New Style Special Reinforced (SR) Threaded Tank Adapters with EPDM Gaskets (continued)

Fipt x SR Fipt - Stainless Steel Collar

8172E-010CSR	1	25	0	101	88.12
8172E-012CSR	1-1/4	20	0	101	124.38
8172E-015CSR	1-1/2	20	0	101	144.60
8172E-020CSR	2	15	0	101	177.48
8172E-025CSR	2-1/2	4	0	101	267.74
8172E-030CSR	3	4	0	101	318.73
8172E-040CSR	4	2	0	101	515.99
8172E-060CSR	6	2	0	101	1193.37

CPVC New Style Special Reinforced (SR) Threaded Tank Adapters with FKM Gaskets

Fipt x SR Fipt - Stainless Steel Collar

150 psi Maximum Internal Pressure Rating @ 73°F (23°C)

8172V-002CSR	1/4	25	150	101	105.26
8172V-003CSR	3/8	25	200	101	105.26
8172V-005CSR	1/2	25	0	101	105.26
8172V-007CSR	3/4	25	0	101	119.08
8172V-010CSR	1	25	0	101	137.53
8172V-012CSR	1-1/4	20	0	101	169.80
8172V-015CSR	1-1/2	20	0	101	178.83
8172V-020CSR	2	15	0	101	274.84
8172V-025CSR	2-1/2	4	0	101	397.14
8172V-030CSR	3	4	0	101	472.79
8172V-040CSR	4	2	0	101	1206.41
8172V-060CSR	6	2	0	101	2190.53

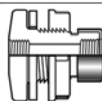

Tank Adapter with Neoprene Gasket (Old Style)

Soc x Fipt

150 psi Maximum Internal Pressure Rating @ 73°F (23°C)

871-005C	1/2	25	0	101	48.33
871-007C	3/4	25	0	101	57.49
871-010C	1	25	0	101	64.53
871-012C	1-1/4	20	0	101	82.31
871-015C	1-1/2	20	0	101	89.62
871-020C	2	15	0	101	126.52
871-030C	3	4	0	101	221.34
871-040C	4	2	0	101	368.87

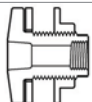

Tank Adapter with Neoprene Gasket (Old Style)

Fipt

150 psi Maximum Internal Pressure Rating @ 73°F (23°C)

872-005C	1/2	25	0	101	64.53
872-007C	3/4	25	0	101	74.51
872-010C	1	25	0	101	81.51
872-012C	1-1/4	20	0	101	115.07
872-015C	1-1/2	20	0	101	125.78
872-020C	2	15	0	101	156.77
872-030C	3	4	0	101	262.63
872-040C	4	2	0	101	414.96

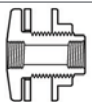

Neoprene Tank Adapter Gasket Only (New Style)

3N-002	1/4	100	0	901	2.71
3N-003	3/8	50	0	901	2.71
3N-005	1/2	10	0	901	2.71
3N-007	3/4	10	0	901	2.91
3N-010	1	10	0	901	3.09
3N-012	1-1/4	10	0	901	4.27
3N-015	1-1/2	10	0	901	5.01
3N-020	2	10	0	901	6.56



Part Number	Size	Std Pk	Mstr Ctn	Disc Code	Price Each
-------------	------	--------	----------	-----------	------------

Neoprene Tank Adapter Gasket Only (New Style) (continued)

3N-025	2-1/2	10	0	901	6.84
3N-030	3	10	0	901	7.14
3N-040	4	10	0	901	19.75
2N-060	6	10	0	901	24.67
3N-080	8	10	0	901	113.14



EPDM Tank Adapter Gasket Only (New Style)

3E-002	1/4	10	0	901	3.15
3E-003	3/8	10	0	901	3.15
3E-005	1/2	10	0	901	3.15
3E-007	3/4	10	0	901	3.25
3E-010	1	10	0	901	5.64
3E-012	1-1/4	10	0	901	8.26
3E-015	1-1/2	10	0	901	8.48
3E-020	2	10	0	901	9.71
3E-025	2-1/2	10	0	901	13.76
3E-030	3	10	0	901	14.79
3E-040	4	10	0	901	22.28
2E-060	6	10	0	901	40.22
3E-080	8	10	0	901	145.99



FKM Tank Adapter Gasket Only (New Style)

3V-002	1/4	10	0	901	11.53
3V-003	3/8	10	0	901	13.59
3V-005	1/2	10	0	901	20.28
3V-007	3/4	10	0	901	25.12
3V-010	1	10	0	901	34.34
3V-012	1-1/4	10	0	901	54.61
3V-015	1-1/2	10	0	901	58.99
3V-020	2	10	0	901	94.48
3V-025	2-1/2	10	0	901	104.38
3V-030	3	10	0	901	108.76
3V-040	4	10	0	901	246.09
2V-060	6	10	0	901	616.03
3V-080	8	10	0	901	1033.18

Neoprene Tank Adapter Gasket Only (Old Style)

2N-005	1/2	10	0	901	2.71
2N-007	3/4	10	0	901	2.91
2N-010	1	10	0	901	3.09
2N-015	1-1/4 OR 1-1/2	10	0	901	5.01
2N-020	2	10	0	901	6.56
2N-030	3	10	0	901	7.14
2N-040	4	10	0	901	19.75



EPDM Tank Adapter Gasket Only (Old Style)

2E-005	1/2	10	0	901	3.15
2E-007	3/4	10	0	901	3.25
2E-010	1	10	0	901	5.64
2E-015	1-1/4 OR 1-1/2	10	0	901	8.48
2E-020	2	10	0	901	9.71
2E-030	3	10	0	901	14.79
2E-040	4	10	0	901	22.28

**Schedule 80 CPVC Industrial Products & Accessories
Tank Adapters & Expansion Joints**



Tank Adapters

Part Number	Size	Std Pk	Mstr Ctn	Disc Code	Price Each
-------------	------	--------	----------	-----------	------------

Wrench Sets (New Style)
Body Wrench & Nut Wrench



TAW-002	1/4	1	25	299	21.89
TAW-003	3/8	1	25	299	21.89
TAW-005	1/2	1	25	299	21.89
TAW-007	3/4	1	25	299	22.32
TAW-010	1	1	25	299	23.21
TAW-012	1-1/4	1	20	299	26.18
TAW-015	1-1/2	1	20	299	28.40
TAW-020	2	1	10	299	32.35
TAW-025	2-1/2	1	10	299	35.79
TAW-030	3	1	10	299	39.44
TAW-040	4	1	10	299	42.26

Individual Body Wrench (New Style)



TAW1-002	1/4	500	0	299	12.28
TAW1-003	3/8	400	0	299	12.28
TAW1-005	1/2	250	0	299	12.28
TAW1-007	3/4	220	0	299	12.52
TAW1-010	1	200	0	299	13.03
TAW1-012	1-1/4	300	0	299	14.76

Part Number	Size	Std Pk	Mstr Ctn	Disc Code	Price Each
-------------	------	--------	----------	-----------	------------

Individual Body Wrench (New Style) (continued)

TAW1-015	1-1/2	150	0	299	15.89
TAW1-020	2	100	0	299	17.25
TAW1-025	2-1/2	80	0	299	18.03
TAW1-030	3	74	0	299	22.61
TAW1-040	4	35	0	299	23.26

Individual Nut Wrench (New Style)



TAW2-002	1/4	300	0	299	12.28
TAW2-003	3/8	250	0	299	12.28
TAW2-005	1/2	200	0	299	12.28
TAW2-007	3/4	160	0	299	12.52
TAW2-010	1	110	0	299	13.03
TAW2-012	1-1/4	200	0	299	14.76
TAW2-015	1-1/2	120	0	299	15.89
TAW2-020	2	100	0	299	17.25
TAW2-025	2-1/2	50	0	299	18.03
TAW2-030	3	40	0	299	22.61
TAW2-040	4	35	0	299	23.26

Expansion Joints

Part Number	Size	Std Pk	Mstr Ctn	Disc Code	Price Each
-------------	------	--------	----------	-----------	------------

CPVC Fabricated Expansion Joints
6" Travel with FKM O-rings



1/2" - 2" 235 psi @ 73°F (23°C)
2-1/2" - 12" 150 psi @ 73°F (23°C)

826-005X6C	1/2	10	0	085	387.05
826-007X6C	3/4	6	0	085	423.54
826-010X6C	1	5	0	085	457.80
826-012X6C	1-1/4	4	0	085	480.84
826-015X6C	1-1/2	4	0	085	524.06
826-020X6C	2	2	0	085	664.05
826-025X6C	2-1/2	1	0	085	788.00
826-030X6C	3	1	0	085	915.43
826-040X6C	4	1	0	085	1350.14
826-060X6C	6	1	0	085	1451.36
826-080X6C	8	1	0	085	2753.19
826-100X6C	10	1	0	085	3514.77
826-120X6C	12	1	0	085	4662.63

EPDM O-rings available on special order. Add an "E" preceding the dash (-) separator, e.g. 826E-005X6C

CPVC Fabricated Expansion Joints
12" Travel with FKM O-rings



1/2" - 2" 235 psi @ 73°F (23°C)
2-1/2" - 12" 150 psi @ 73°F (23°C)

826-005X12C	1/2	10	0	085	394.20
826-007X12C	3/4	6	0	085	452.06
826-010X12C	1	5	0	085	482.24
826-012X12C	1-1/4	4	0	085	764.46
826-015X12C	1-1/2	4	0	085	605.32
826-020X12C	2	2	0	085	772.65
826-025X12C	2-1/2	1	0	085	1169.72
826-030X12C	3	1	0	085	940.04
826-040X12C	4	1	0	085	1557.18
826-060X12C	6	1	0	085	1715.44

Part Number	Size	Std Pk	Mstr Ctn	Disc Code	Price Each
-------------	------	--------	----------	-----------	------------

CPVC Fabricated Expansion Joints (continued)
12" Travel with FKM O-rings

826-080X12C	8	1	0	085	3284.37
826-100X12C	10	1	0	085	3847.76

EPDM O-rings available on special order. Add an "E" preceding the dash (-) separator, e.g. 826E-005X12C

CPVC Elastomer Expansion Joint
with EPDM Bellows Soc



150 psi Maximum Internal Pressure Rating @ 73°F (23°C)

EJ22-007C	3/4	10	0	085	205.88
EJ22-010C	1	10	0	085	234.92
EJ22-012C	1-1/4	15	0	085	256.68
EJ22-015C	1-1/2	10	0	085	314.45
EJ22-020C	2	8	0	085	392.46
EJ22-025C	2-1/2	4	0	085	573.51
EJ22-030C	3	2	0	085	779.00

CPVC Elastomer Expansion Joint
with EPDM Bellows SR Fipt - Stainless Steel Collar



150 psi Maximum Internal Pressure Rating @ 73°F (23°C)

EJ21-007CSR	3/4	10	0	085	208.22
EJ21-010CSR	1	10	0	085	239.45
EJ21-012CSR	1-1/4	15	0	085	264.60
EJ21-015CSR	1-1/2	10	0	085	337.27
EJ21-020CSR	2	8	0	085	445.81
EJ21-025CSR	2-1/2	4	0	085	619.13
EJ21-030CSR	3	2	0	085	824.60



Schedule 80 CPVC Industrial Products & Accessories
Pipe Flanges

Part Number	Size	Std Pk	Mstr Ctn	Disc Code	Price Each
-------------	------	--------	----------	-----------	------------

Flange One Piece Soc



150 psi Maximum Internal Pressure Rating @ 73°F (23°C)

851-005C	1/2	25	0	090	26.87
851-007C	3/4	25	0	090	27.49
851-010C	1	15	0	090	30.02
851-012C	1-1/4	15	0	090	36.64
851-015C	1-1/2	20	0	090	40.67
851-020C	2	10	0	090	49.23
851-025C	2-1/2	10	0	090	102.01
851-030C	3	10	0	090	106.67
851-040C	4	5	0	090	144.12
851-050C	5	5	0	090	264.12
851-060C	6	5	0	090	245.51
851-080C	8	2	0	090	560.85

Flange One Piece Fipt



150 psi Maximum Internal Pressure Rating @ 73°F (23°C)

852-005C	1/2	25	0	090	37.57
852-007C	3/4	25	0	090	45.55
852-010C	1	15	0	090	49.71
852-012C	1-1/4	15	0	090	68.99
852-015C	1-1/2	20	0	090	73.03
852-020C	2	10	0	090	74.37
852-025C	2-1/2	10	0	090	120.72
852-030C	3	10	0	090	119.78
852-040C	4	5	0	090	186.21

Special Reinforced Flange One Piece Threaded



SR Fipt - Stainless Steel Collar

150 psi Maximum Internal Pressure Rating @ 73°F (23°C)

852-005CSR	1/2	25	0	096	20.65
852-007CSR	3/4	25	0	096	25.05
852-010CSR	1	15	0	096	27.41
852-012CSR	1-1/4	15	0	096	37.93
852-015CSR	1-1/2	15	0	096	40.21
852-020CSR	2	10	0	096	41.19
852-025CSR	2-1/2	10	0	096	66.27
852-030CSR	3	10	0	096	65.76
852-040CSR	4	5	0	096	123.22

Blind Flange

1/2" - 12" Molded - 150 psi Maximum Internal Pressure Rating @ 73°F (23°C)
14" - 24" Fabricated - 50 psi Maximum Internal Pressure Rating @ 73°F (23°C)

853-005C	1/2	25	100	090	40.28
853-007C	3/4	25	0	090	43.67
853-010C	1	20	0	090	54.44
853-012C	1-1/4	20	0	090	61.60
853-015C	1-1/2	15	0	090	86.21
853-020C	2	10	0	090	90.57
853-025C	2-1/2	10	0	090	137.01
853-030C	3	10	0	090	170.33
853-040C	4	8	0	090	230.72
853-060C	6	5	0	090	387.01
853-080C	8	5	0	090	717.85
853-100C	10	3	0	091	1294.36
853-120C	12	2	0	091	2174.52
853-140CF	14	1	0	097	2527.08
853-160CF	16	1	0	097	3918.21
853-180CF	18	1	0	097	4830.15

Part Number	Size	Std Pk	Mstr Ctn	Disc Code	Price Each
-------------	------	--------	----------	-----------	------------

Blind Flange (continued)

853-200CF	20	1	0	097	5175.66
853-240CF	24	1	0	097	6297.71

Flange Van Stone Style with Plastic Ring Soc



150 psi Maximum Internal Pressure Rating @ 73°F (23°C)

854-005C	1/2	25	0	090	27.05
854-007C	3/4	25	0	090	27.66
854-010C	1	15	0	090	30.21
854-012C	1-1/4	15	0	090	36.88
854-015C	1-1/2	20	0	090	40.95
854-020C	2	10	0	090	49.59
854-025C	2-1/2	10	0	090	102.73
854-030C	3	10	0	090	107.56
854-040C	4	5	0	090	145.25
854-050C	5	5	0	090	247.51
854-060C	6	5	0	090	247.51
854-080C	8	2	0	090	744.72
854-100C	10	2	0	091	1792.81
854-120C	12	2	0	091	2690.18
854-140C	14	1	0	091	3031.38
854-160C	16	1	0	091	3789.24
854-180C	18	1	0	091	6151.38

Flange Van Stone Style with Plastic Ring Spig



150 psi Maximum Internal Pressure Rating @ 73°F (23°C)

856-005C	1/2	25	0	090	31.28
856-007C	3/4	25	0	090	33.58
856-010C	1	15	0	090	38.13
856-012C	1-1/4	15	0	090	47.18
856-015C	1-1/2	15	0	090	52.17
856-020C	2	10	0	090	73.02
856-025C	2-1/2	10	0	090	114.37
856-030C	3	10	0	090	125.24
856-040C	4	5	0	090	128.88
856-060C	6	4	0	090	281.40
856-080C	8	2	0	090	573.59
856-100C	10	2	0	091	1926.06
856-120C	12	2	0	091	2893.23
856-140CF	14	1	0	097	3078.41
856-160CF	16	1	0	097	3813.33

Flange Van Stone Style with Plastic Solid Ring Soc



150 psi Maximum Internal Pressure Rating @ 73°F (23°C)

S854-030C	3	10	0	090	153.63
S854-040C	4	5	0	090	207.55
S854-060C	6	4	0	090	353.57
S854-080C	8	2	0	090	1063.86
S854-100C	10	2	0	091	2561.17
S854-120C	12	2	0	091	3843.11

Flange Van Stone Style Class 300 Bolt Pattern Fabricated with Plastic Ring Soc



Molded with fabricated ring - 150 psi = maximum internal pressure rating @ 73°F (23°C)

854-005CL300C	1/2	1	25	097	205.84
854-007CL300C	3/4	1	25	097	275.78
854-010CL300C	1	1	15	097	336.27

Schedule 80 CPVC Industrial Products & Accessories
Pipe Flanges & Van Stone Style Flange Replacement Split Rings



Pipe Flanges

Part Number	Size	Std Pk	Mstr Ctn	Disc Code	Price Each
-------------	------	--------	----------	-----------	------------

Flange Van Stone Style Class 300 Bolt Pattern
Fabricated with Plastic Ring (continued)

Part Number	Size	Std Pk	Mstr Ctn	Disc Code	Price Each
854-012CL300C	1-1/4	1	15	097	357.25
854-015CL300C	1-1/2	1	20	097	370.95
854-020CL300C	2	1	10	097	412.06
854-025CL300C	2-1/2	1	10	097	490.33
854-030CL300C	3	1	10	097	532.87
854-040CL300C	4	1	5	097	840.37
854-060CL300C	6	1	4	097	1586.91
854-080CL300C	8	1	3	097	1826.03
854-100CL300C	10	1	2	097	2064.60
854-120CL300C	12	1	0	097	2579.31
854-140CL300C	14	1	0	097	2864.68
854-160CL300C	16	1	0	097	3014.23

Flange Van Stone Style with Plastic Ring
Fipt



150 psi Maximum Internal Pressure Rating @ 73°F (23°C)

Part Number	Size	Std Pk	Mstr Ctn	Disc Code	Price Each
855-005C	1/2	25	0	090	37.82
855-007C	3/4	25	0	090	45.84
855-010C	1	15	0	090	50.05

Part Number	Size	Std Pk	Mstr Ctn	Disc Code	Price Each
-------------	------	--------	----------	-----------	------------

Flange Van Stone Style with Plastic Ring (continued)
Fipt

855-012C	1-1/4	15	0	090	68.88
855-015C	1-1/2	20	0	090	73.55
855-020C	2	10	0	090	74.93
855-025C	2-1/2	10	0	090	120.63
855-030C	3	10	0	090	120.63
855-040C	4	5	0	090	187.54
855-060C ¹	6	1	0	090	317.48
855-080C ¹	8	1	2	090	487.97
855-080CF	8	1	2	097	433.74

¹ - Flange assembled with molded Female Adapter

Flange Van Stone Style with Plastic Ring ASTM
Soc x Multi-bolt Pattern Ring



150 psi Maximum Internal Pressure Rating @ 73°F (23°C)

Part Number	Size	Std Pk	Mstr Ctn	Disc Code	Price Each
M854-020C	2	10	0	090	48.63
M854-060C	6	4	0	090	247.51
M854-080C	8	2	0	090	744.72

Van Stone Style Flange Replacement Split Rings

Part Number	Size	Std Pk	Mstr Ctn	Disc Code	Price Each
-------------	------	--------	----------	-----------	------------

Application & Use of Van Stone Style
Flange Replacement Split Rings



Designed for easy Van Stone style flange ring replacement in the event of system modification, repair, or improper assembly without having to remove existing flange hub. Split rings are made as a direct replacement of existing one-piece rings used on Spears® brand only of Van Stone style flanges with ANSI Class 150 bolt pattern plastic rings. Remove old ring to be replaced then simply place the split ring sections around hub and install flange bolts (not included) through special designed section overlap to hold in position. Install appropriate user supplied bolts, washers and gasket (see Flange Gasket and Bolt Hardware Kits in this catalog); torque to specifications according to normal flange assembly. Split rings are a set of either 2-pieces or 4-pieces (illustrated) sections depending on size, in regular PVC, Glass Filled PVC, or CPVC for flange type and sizes listed.

CPVC Flange Replacement Split Rings
For Spears® Flanges with CPVC Rings



854-005-1SC	1/2	10	0	090	78.55
854-007-1SC	3/4	10	0	090	83.38
854-010-1SC	1	10	0	090	93.25
854-012-1SC	1-1/4	10	0	090	95.06
854-015-1SC	1-1/2	20	0	090	97.40
854-020-1SC	2	40	0	090	129.27
854-025-1SC	2-1/2	10	0	090	149.54
854-030-1SC	3	10	0	090	165.79
854-040-1SC	4	10	0	090	175.58
854-050-1SC	5	10	0	090	240.72
854-060-1SC	6	5	0	090	284.84
854-080-1SC	8	4	0	090	325.43
854-100-1SC	10	4	0	091	410.81
854-120-1SC	12	2	0	091	509.17
854-140-1SC	14	1	0	091	697.42
854-160-1SC	16	1	0	091	866.39
854-180-1SC	18	1	0	091	941.00
854-200-1SC	20	1	0	097	5998.99

Part Number	Size	Std Pk	Mstr Ctn	Disc Code	Price Each
-------------	------	--------	----------	-----------	------------

CPVC Flange Replacement Split Rings (continued)
For Spears® Flanges with CPVC Rings

854-240-1SC	24	1	0	097	6119.36
-------------	----	---	---	-----	---------

Fits 854-xxxC Socket, 855-xxxC Threaded, and 856-xxxC Spigot hub configurations



Schedule 80 CPVC Industrial Products & Accessories Flange Insulating Joints & Flange Bolt Kits

Flange Insulating Joints

Part Number	Size	Std Pk	Mstr Ctn	Disc Code	Price Each
Flange Insulating Joints - Class 150 Bolt Pattern					
PP Flange Spacer with PVC Bolt Isolators					
Size = Nominal Flange Diameter x Thickness (in.) For Dielectric Insulation Between Dissimilar Metal Flanges 300 psi Maximum Internal Pressure Rating @ 73°F (23°C)					
IJ-030-010P	3X1	1	0	016	460.69
IJ-040-010P	4X1	1	0	016	514.74
IJ-060-010P	6X1	1	0	016	611.82
IJ-080-010P	8X1	1	0	016	710.06
IJ-100-010P	10X1	1	0	016	1443.20
IJ-120-010P	12X1	1	0	016	1563.13
IJ-140-010P	14X1	1	0	016	2025.46
IJ-160-010P	16X1	1	0	016	2573.78
IJ-180-010P	18X1	1	0	016	3445.23
IJ-200-010P	20X1	1	0	016	4447.74
IJ-240-010P	24X1	1	0	016	6177.09



Part Number	Size	Std Pk	Mstr Ctn	Disc Code	Price Each
Flange Insulating Joints - Class 300 Bolt Pattern					
PP Flange Spacer with PVC Bolt Isolators					
Size = Nominal Flange Diameter x Thickness (in.) For Dielectric Insulation Between Dissimilar Metal Flanges 300 psi Maximum Internal Pressure Rating @ 73°F (23°C)					
IJ300-030-010P	3X1	1	0	016	678.67
IJ300-040-010P	4X1	1	0	016	754.83
IJ300-060-010P	6X1	1	0	016	1156.18
IJ300-080-010P	8X1	1	0	016	1442.38
IJ300-100-010P	10X1	1	0	016	2392.84
IJ300-120-010P	12X1	1	0	016	3144.45
IJ300-140-010P	14X1	1	0	016	3961.23
IJ300-160-010P	16X1	1	0	016	4223.97
IJ300-180-010P	18X1	1	0	016	5278.95
IJ300-200-010P	20X1	1	0	016	6116.11
IJ300-240-010P	24X1	1	0	016	7509.49



Flange Bolt Kits Bolt Kit Selection Guide

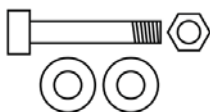

Order Gaskets & Bolt Kits Separately

- Kit Contains All Bolts, Nuts, & Flat Washers for Specified Flange Size
- For Connecting Two (2) Mating Spears® Flanges
- Pre-coated, Anti-seize Lubricated Bolts
- Available in Zinc Coated Steel, Type 304 Stainless Steel or Type 316 Stainless Steel

Flange Size	Bolts ¹ Per Kit	Diameter (in.-TPI)	Length (in.)	Hardware Kit Part Number		
				Zinc	316 SS	304 SS
1/2 & 3/4	4	1/2-13	2	HK-005	HK1-005	HK2-005
1 & 1-1/4	4	1/2-13	2-1/4	HK-010	HK1-010	HK2-010
1-1/2	4	1/2-13	2-1/2	HK-015	HK1-015	HK2-015
2	4	5/8-11	3	HK-020	HK1-020	HK2-020
2-1/2	4	5/8-11	3-1/4	HK-025	HK1-025	HK2-025
3	4	5/8-11	3-1/2	HK-030	HK1-030	HK2-030
4	8	5/8-11	3-1/2	HK-040	HK1-040	HK2-040
5 & 6	8	3/4-10	4	HK-060	HK1-060	HK2-060
8	8	3/4-10	4-1/2	HK-080	HK1-080	HK2-080
10 & 12	12	7/8-9	5	HK-120	HK1-120	HK2-120

1 - Each Bolt includes Nut & two (2) Flat Washers

Part Number	Size	Std Pk	Mstr Ctn	Disc Code	Price Each
Zinc Plated Steel Flange Bolt Hardware Kits					
For Connection of 2-Spears® Flanges Includes Bolts, Nuts & Flat Washers					
HK-005	1/2	1	10	017	10.03
HK-010	3/4 & 1	1	10	017	12.54
HK-015	1-1/4 & 1-1/2	1	10	017	18.85
HK-020	2	1	10	017	25.23
HK-025	2-1/2	1	10	017	30.25
HK-030	3	1	10	017	34.81
HK-040	4	1	5	017	72.12
HK-060	5 & 6	1	5	017	80.21
HK-080	8	1	0	017	94.00
HK-120	10 & 12	1	0	017	127.18



Type 316 Stainless Steel Flange Bolt Hardware Kits

For Connection of 2-Spears® Flanges Includes Bolts, Nuts & Flat Washers

HK1-005	1/2	1	10	017	30.11
---------	------------	---	----	-----	-------



Part Number	Size	Std Pk	Mstr Ctn	Disc Code	Price Each
Type 316 Stainless Steel Flange Bolt Hardware Kits (continued)					
For Connection of 2-Spears® Flanges Includes Bolts, Nuts & Flat Washers					
HK1-010	3/4 & 1	1	10	017	43.37
HK1-015	1-1/4 & 1-1/2	1	10	017	47.78
HK1-020	2	1	10	017	57.46
HK1-025	2-1/2	1	10	017	61.59
HK1-030	3	1	10	017	81.26
HK1-040	4	1	5	017	162.96
HK1-060	5 & 6	1	5	017	212.54
HK1-080	8	1	0	017	266.69
HK1-120	10 & 12	1	0	017	542.58

Type 304 Stainless Steel Flange Bolt Hardware Kits

For Connection of 2-Spears® Flanges Includes Bolts, Nuts & Flat Washers

HK2-005	1/2	1	10	017	26.34
HK2-010	3/4 & 1	1	10	017	37.57
HK2-015	1-1/4 & 1-1/2	1	10	017	44.26



**Schedule 80 CPVC Industrial Products & Accessories
Flange Bolt Kits & Full-Faced Flange Gaskets**



Flange Bolt Kits

Part Number	Size	Std Pk	Mstr Ctn	Disc Code	Price Each
-------------	------	--------	----------	-----------	------------

Type 304 Stainless Steel Flange Bolt Hardware Kits (continued)

For Connection of 2-Spears® Flanges Includes Bolts, Nuts & Flat Washers

HK2-020	2	1	10	017	52.06
HK2-025	2-1/2	1	10	017	55.20
HK2-030	3	1	10	017	68.55
HK2-040	4	1	5	017	137.09
HK2-060	5 & 6	1	5	017	144.51

Part Number	Size	Std Pk	Mstr Ctn	Disc Code	Price Each
-------------	------	--------	----------	-----------	------------

Type 304 Stainless Steel Flange Bolt Hardware Kits (continued)

For Connection of 2-Spears® Flanges Includes Bolts, Nuts & Flat Washers

HK2-080	8	1	0	017	190.02
HK2-120	10 & 12	1	0	017	336.78

**Full-Faced Flange Gaskets
Gasket Selection Guide**

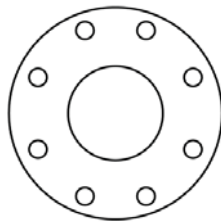

Order Gaskets & Bolt Kits Separately

- 1/8" Full-Face design with ANSI Class 150 Bolt Patterns
- Pressure rated to 150 psi @ 73°F
- Available in Buna-N, EPDM, or FKM

Flange Size	Bolt Holes	Gasket Part Number		
		Buna-N	EPDM	FKM
1/2	4	GK1-005	GK2-005	GK3-005
3/4	4	GK1-007	GK2-007	GK3-007
1	4	GK1-010	GK2-010	GK3-010
1-1/4	4	GK1-012	GK2-012	GK3-012
1-1/2	4	GK1-015	GK2-015	GK3-015
2	4	GK1-020	GK2-020	GK3-020
2-1/2	4	GK1-025	GK2-025	GK3-025
3	4	GK1-030	GK2-030	GK3-030
4	8	GK1-040	GK2-040	GK3-040
5	8	GK1-050	GK2-050	GK3-050
6	8	GK1-060	GK2-060	GK3-060
8	8	GK1-080	GK2-080	GK3-080
10	12	GK1-100	GK2-100	GK3-100
12	12	GK1-120	GK2-120	GK3-120

Buna-N Full-Faced Flange Gaskets

Part Number	Size	Std Pk	Mstr Ctn	Disc Code	Price Each
GK1-005	1/2	1	25	017	3.22
GK1-007	3/4	1	25	017	3.69
GK1-010	1	1	25	017	3.80
GK1-012	1-1/4	1	25	017	3.89
GK1-015	1-1/2	1	25	017	4.18
GK1-020	2	1	25	017	4.67
GK1-025	2-1/2	1	25	017	5.14
GK1-030	3	1	25	017	7.91
GK1-040	4	1	25	017	8.84
GK1-050	5	1	25	017	10.48
GK1-060	6	1	25	017	10.77
GK1-080	8	1	25	017	14.20
GK1-100	10	1	25	017	18.02
GK1-120	12	1	25	017	24.31
GK1-140	14	1	25	017	47.02
GK1-160	16	1	25	017	226.21
GK1-180	18	1	25	017	257.63
GK1-240	24	1	25	017	311.31

EPDM Full-Faced Flange Gaskets

Part Number	Size	Std Pk	Mstr Ctn	Disc Code	Price Each
GK2-005	1/2	1	25	017	4.27
GK2-007	3/4	1	25	017	4.55
GK2-010	1	1	25	017	4.75
GK2-012	1-1/4	1	25	017	4.99
GK2-015	1-1/2	1	25	017	5.36
GK2-020	2	1	25	017	6.54
GK2-025	2-1/2	1	25	017	7.85
GK2-030	3	1	25	017	11.54
GK2-040	4	1	25	017	13.14
GK2-050	5	1	25	017	16.43

EPDM Full-Faced Flange Gaskets (continued)

Part Number	Size	Std Pk	Mstr Ctn	Disc Code	Price Each
GK2-060	6	1	25	017	17.24
GK2-080	8	1	25	017	22.97
GK2-100	10	1	25	017	29.93
GK2-120	12	1	25	017	41.18
GK2-140	14	1	25	017	100.45
GK2-160	16	1	25	017	178.22
GK2-180	18	1	25	017	208.16
GK2-200	20	1	25	017	241.60
GK2-240	24	1	25	017	364.73

FKM Full-Faced Flange Gaskets

Part Number	Size	Std Pk	Mstr Ctn	Disc Code	Price Each
GK3-005	1/2	1	25	017	15.25
GK3-007	3/4	1	25	017	18.11
GK3-010	1	1	25	017	20.01
GK3-012	1-1/4	1	5	017	22.59
GK3-015	1-1/2	1	25	017	28.49
GK3-020	2	1	25	017	39.83
GK3-025	2-1/2	1	25	017	53.27
GK3-030	3	1	25	017	119.04
GK3-040	4	1	25	017	137.42
GK3-050	5	1	25	017	160.20
GK3-060	6	1	25	017	181.75
GK3-080	8	1	25	017	258.94
GK3-100	10	1	25	017	344.42
GK3-120	12	1	25	017	485.28
GK3-140	14	1	25	017	711.26
GK3-160	16	1	25	017	810.63
GK3-180	18	1	25	017	912.00
GK3-240	24	1	25	017	1160.91



Schedule 80 CPVC Industrial Products & Accessories
CPVC Cut-in Kit

When planned system changes are needed, system downtime can be a major concern. Spears® Flange Cut-in Kit minimizes downtime for actual cut-in to allow new connection in just minutes. Kit provides all necessary components to create a flanged joint for connection to system alterations in just minutes. Special Flange Hub can be cemented to piping and allowed to cure before shutting down and cutting into system. This allows immediate joining to mating flange (included) that can also be pre-assembled to desired alteration piping.

Kit includes special Split Flange Socket Hub, O-ring Sealed Hub Body, Stainless Steel Clamp, Split Ring, Full-Faced EPDM or FKM Gasket, Mating Flange Hub & Ring, and complete set of Stainless Steel Bolts, Flat Washers and anti-seize Brass Nuts to make the final joint. Available for IPS Pipe Sizes 2" - 12".



Pressure Rated to 150 psi @ 73°F (22°C)
 Maximum Service Temperature
 PVC = 140°F (60°C)
 CPVC = 200°F (93°C)
 Temperature/Pressure De-ratings Apply

Size (in.)	H	L	M
2	2-3/8	4-7/8	6
2-1/2	3-3/4	5-1/2	7
3	4	5-7/8	7-1/2
4	4-7/8	7-1/8	9
6	5-7/8	9	11
8	6-3/4	10-7/8	13-1/2
10	8-3/8	13-1/2	16
12	10	16-3/4	19

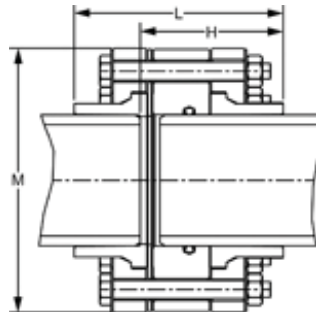

Flange Cut-in Kit

Size	EPDM Gasket	FKM Gasket	Std Pk	Mstr Pk	Disc Code
2	FCKE-020C 693.79	FCKV-020C 732.07	1	0	017
2-1/2	FCKE-025C 739.29	FCKV-025C 800.29	1	0	017
3	FCKE-030C 805.37	FCKV-030C 836.33	1	0	017
4	FCKE-040C 1232.08	FCKV-040C 1279.94	1	0	017
6	FCKE-060C 1995.37	FCKV-060C 2273.05	1	0	017
8	FCKE-080C 2532.21	FCKV-080C 2884.84	1	0	017
10	FCKE-100C 4101.17	FCKV-100C 4237.68	1	0	017
12	FCKE-120C 4880.05	FCKV-120C 5094.11	1	0	017