



SPEARS® Patented SR Design Sprinkler Head Adapters



SPEARS® Patented Special Reinforced (SR) plastic female thread design is one of the most significant advancements in the use of CPVC Fire Sprinkler System threaded fittings. Not just an added ring, this unique precompression design compensates for expansion forces generated from tapered pipe thread joint make-up. Radial stress is no longer a problem in normal installations and easily managed in severe over-tightening situations.

Contains and Compensates for Radial Stress...

Radial stress, generated by tightening of tapered pipe threads, exerts tremendous expansion force on female plastic thread fittings. When subjected to over-tightening - even accidentally - these forces can literally split the fitting. Spears® patented SR Adapter design not only alleviates this problem by containing expansion forces with its special reinforced collar, but additionally compensates for expansion stress through thermoplastic material compression. Stresses are equalized at normal joint make-up. The following graph illustrates this effect in a comparison of conventional plastic female thread fittings with Spears® SR adapters when taken to failure.

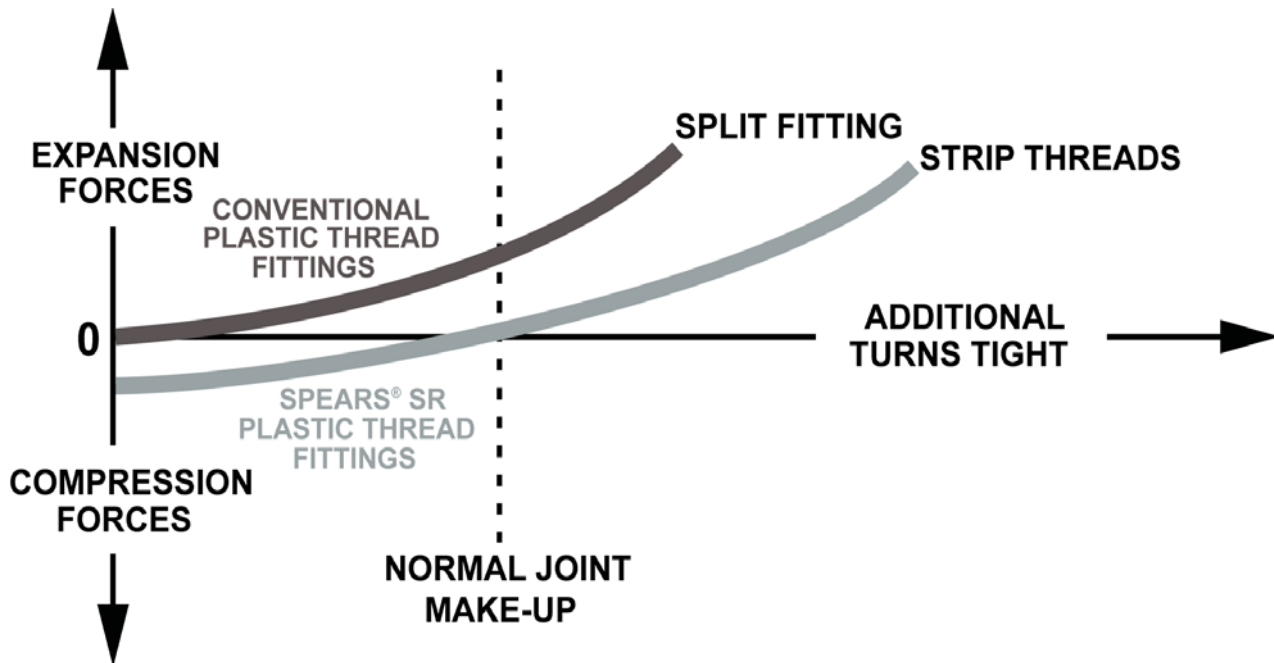

Another Quality SPEARS® Product Designed for Performance, Customer Satisfaction and Service.

FlameGuard® CPVC Fire Sprinkler Products
FlameGuard® CPVC Fire Sprinkler Piping Products



Part Number	Size	Std Pk	Mstr Ctn	Disc Code	Price Each
-------------	------	--------	----------	-----------	------------

FlameGuard® CPVC Fire Sprinkler Pipe
SDR 13.5 10' Lengths, Price Per Foot



List Price Per Foot

CP-007-10	3/4	260	0	071	1.92
CP-010-10	1	170	0	071	2.96
CP-012-10	1-1/4	90	0	071	4.63
CP-015-10	1-1/2	70	0	071	6.40
CP-020-10	2	50	0	071	9.57
CP-025-10	2-1/2	40	0	071	14.60
CP-030-10	3	30	0	071	22.19

Pipe

SDR 13.5, 15' Lengths, Price Per Foot



List Price Per Foot

CP-007	3/4	390	0	071	1.92
CP-010	1	255	0	071	2.96
CP-012	1-1/4	135	0	071	4.63
CP-015	1-1/2	105	0	071	6.40
CP-020	2	75	0	071	9.57
CP-025	2-1/2	60	0	071	14.60
CP-030	3	45	0	071	22.19

Tee

Socket x Socket x Socket



4201-007	3/4	20	220	070	3.73
4201-010	1	15	120	070	7.56
4201-012	1-1/4	10	0	070	11.29
4201-015	1-1/2	10	0	070	16.61
4201-020	2	10	0	070	24.52
4201-025	2-1/2	10	0	070	39.95
4201-030	3	5	0	070	62.60

Reducing Tee

Socket x Socket x Socket



4201-102	3/4X1	20	0	070	6.38
4201-125	1X3/4X3/4	15	150	070	6.38
4201-126	1X3/4X1	15	0	070	6.38
4201-131	1X3/4	20	0	070	6.38
4201-157	1-1/4X1X3/4	15	0	070	11.78
4201-158	1-1/4X1X1	15	0	070	11.78
4201-159	1-1/4X1X1-1/4	15	0	070	11.78
4201-167	1-1/4X3/4	15	0	070	11.78
4201-168	1-1/4X1	15	0	070	11.78
4201-169	1-1/4X1-1/2	10	0	070	14.22
4201-201	1-1/2X1-1/4X3/4	10	0	070	14.22
4201-202	1-1/2X1-1/4X1	10	0	070	14.22
4201-210	1-1/2X3/4	15	0	070	14.22
4201-211	1-1/2X1	10	0	070	14.22
4201-212	1-1/2X1-1/4	10	0	070	14.22
4201-213	1-1/2X2	10	0	070	22.57
4201-248	2X3/4	10	0	070	22.57
4201-249	2X1	10	0	070	22.57
4201-250	2X1-1/4	10	0	070	22.57
4201-251	2X1-1/2	10	0	070	22.57
4201-289	2-1/2X1	10	0	070	31.03
4201-290	2-1/2X1-1/4	10	0	070	31.03
4201-291	2-1/2X1-1/2	10	0	070	31.03
4201-292 ¹	2-1/2X2	10	0	070	31.03
4201-335	3X1	5	0	070	35.81
4201-336 ¹	3X1-1/4	5	0	070	35.81
4201-337 ¹	3X1-1/2	5	0	070	35.81
4201-338	3X2	5	0	070	35.81

Part Number	Size	Std Pk	Mstr Ctn	Disc Code	Price Each
-------------	------	--------	----------	-----------	------------

Reducing Tee (continued)

Socket x Socket x Socket

4201-339	3X2-1/2	6	0	070	35.81
----------	---------	---	---	-----	-------

¹Outlet sized with Bushing

TorqueSafe™ Sprinkler Head Tee - Gasket Sealed Brass Thread Insert Style

Socket x Socket x Gasket FIPT With Elastomer Seal - Use NO Thread Sealant

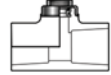

4202-101 G	3/4X1/2	50	0	076	13.83
4202-124 G	1X3/4X1/2	50	0	076	14.93
4202-130 G	1X1/2	50	0	076	14.93
4202-166 G	1-1/4X1/2	15	0	076	24.89
4202-209 G	1-1/2X1/2	10	0	076	32.79
4202-247 G	2X1/2	10	0	076	46.24

FIPT With Elastomer Seal - Use NO Thread Sealant. Not intended to convey or dispense water for human consumption through drinking or cooking

Sprinkler Head Tee - Brass Thread Insert Style

Socket x Socket x FIPT

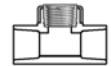

4202-101	3/4X1/2	50	0	076	13.83
4202-124	1X3/4X1/2	50	0	076	14.93
4202-130	1X1/2	50	0	076	14.93
4202-010	1	10	40	076	38.39
4202-156	1-1/4X1X1/2	15	0	076	24.89
4202-166	1-1/4X1/2	15	0	076	24.89
4202-199	1-1/2X1-1/4X1/2	10	0	076	32.79
4202-209	1-1/2X1/2	10	0	076	32.79
4202-237	2X1-1/2X1/2	10	0	076	46.24
4202-247	2X1/2	10	0	076	46.24

Not intended to convey or dispense water for human consumption through drinking or cooking

TorqueSafe™ Sprinkler Head Tee - Gasket Sealed Brass Thread Insert Style

Socket x Gasket FIPT x Socket With Elastomer Seal - Use NO Thread Sealant

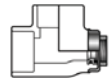

4203-122 G	1X1/2X1	50	0	076	24.52
------------	---------	----	---	-----	-------

FIPT With Elastomer Seal - Use NO Thread Sealant

Not intended to convey or dispense water for human consumption through drinking or cooking

Sprinkler Head Tee - Brass Thread Insert Style

Socket x FIPT x Socket

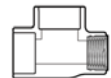

4203-122	1X1/2X1	50	0	076	24.52
----------	---------	----	---	-----	-------

Not intended to convey or dispense water for human consumption through drinking or cooking

Sprinkler Head Tee - Special Reinforced Plastic Thread Style

Socket x Socket x SR FIPT - Stainless Steel Collar

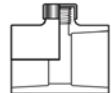

4202-010SR	1	15	0	076	20.40
4202-101SR	3/4X1/2	50	0	076	7.36
4202-124SR	1X3/4X1/2	50	0	076	7.95
4202-130SR	1X1/2	50	0	076	7.95
4202-156SR	1-1/4X1X1/2	15	0	076	13.25
4202-166SR	1-1/4X1/2	15	0	076	13.25
4202-168SR	1-1/4X1	15	0	076	28.48
4202-199SR	1-1/2X1-1/4X1/2	10	0	076	17.44
4202-209SR	1-1/2X1/2	25	0	076	17.44
4202-211SR	1-1/2X1-1/2X1	10	0	076	17.44
4202-237SR	2X1-1/2X1/2	10	0	076	24.61
4202-247SR	2X1/2	10	0	076	24.61
4202-287SR	2-1/2X1/2	10	0	076	33.73



FlameGuard® CPVC Fire Sprinkler Products
FlameGuard® CPVC Fire Sprinkler Piping Products

Part Number	Size	Std Pk	Mstr Ctn	Disc Code	Price Each
-------------	------	--------	----------	-----------	------------

Sprinkler Head Tee - Special Reinforced Plastic Thread Style

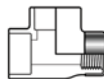

Socket x SR FIPT x Socket - Stainless Steel Collar

4203-122SR	1X1/2X1	50	0	076	8.54
------------	---------	----	---	-----	------

Street Tee

Spigot x Socket x Socket



4244-007	3/4	15	105	070	6.65
4244-010	1	15	0	070	8.87
4244-012	1-1/4	10	0	070	16.12
4244-015	1-1/2	10	0	070	19.51
4244-020	2	10	0	070	28.84

90° EII

Socket x Socket



4206-007	3/4	30	300	070	2.75
4206-010	1	20	200	070	6.11
4206-012	1-1/4	10	100	070	7.80
4206-015	1-1/2	10	0	070	10.89
4206-020	2	25	0	070	13.47
4206-025	2-1/2	5	0	070	26.00
4206-030	3	5	0	070	35.46

Side Outlet EII

Socket x Socket x Socket

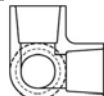

4213-007	3/4	50	0	070	8.95
4213-010	1	25	0	070	12.20

90° Reducing EII

Socket x Socket



4206-131	1X3/4	20	240	070	5.41
----------	-------	----	-----	-----	------

TorqueSafe™ 90° Sprinkler Head Elbow - Gasket Sealed Brass Thread Insert Style

Socket x Gasket FIPT With Elastomer Seal - Use NO Thread Sealant

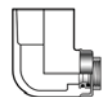

4207-101 G	3/4X1/2	20	120	076	9.14
4207-130 G	1X1/2	15	90	076	12.84
4207-166 G	1-1/4X1/2	10	60	076	17.88

FIPT With Elastomer Seal - Use NO Thread Sealant. Not intended to convey or dispense water for human consumption through drinking or cooking

Sprinkler Head 90° EII - Brass Thread Insert Style

Socket x FIPT

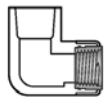

4207-101	3/4X1/2	20	120	076	9.14
4207-130	1X1/2	15	90	076	12.84
4207-131	1X3/4	25	0	076	15.54
4207-166	1-1/4X1/2	10	60	076	17.88

Not intended to convey or dispense water for human consumption through drinking or cooking

Sprinkler Head 90° EII - Special Reinforced Plastic Thread Style

Socket x SR FIPT - Stainless Steel Collar

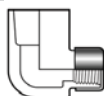

4207-101SR	3/4X1/2	20	180	076	4.85
4207-130SR	1X1/2	10	150	076	6.84
4207-131SR	1X3/4	50	0	076	8.27
4207-166SR	1-1/4X1/2	25	0	076	8.69

Part Number	Size	Std Pk	Mstr Ctn	Disc Code	Price Each
-------------	------	--------	----------	-----------	------------

90° Street EII Spigot x Socket



4209-007	3/4	50	0	070	5.97
4209-010	1	50	0	070	8.82
4209-012	1-1/4	25	0	070	14.51
4209-015	1-1/2	10	0	070	17.67
4209-020	2	25	0	070	26.02

45° EII

Socket x Socket



4217-007	3/4	20	360	070	3.73
4217-010	1	15	240	070	4.43
4217-012	1-1/4	10	120	070	6.49
4217-015	1-1/2	10	0	070	8.93
4217-020	2	10	0	070	11.23
4217-025	2-1/2	5	0	070	20.01
4217-030	3	5	0	070	28.94

45° Street EII Spigot x Socket



4227-010	1	50	0	070	4.43
4227-012	1-1/4	25	0	070	6.49
4227-015	1-1/2	25	0	070	8.03
4227-020	2	20	0	070	11.23

22-1/2° EII

Socket



4216-007	3/4	20	360	070	4.46
4216-010	1	20	240	070	5.76
4216-012	1-1/4	20	0	070	7.79
4216-015	1-1/2	20	0	070	10.71
4216-020	2	20	0	070	13.25
4216-025	2-1/2	5	0	070	27.22
4216-030	3	5	0	070	34.51

22-1/2° Street EII

Spigot x Socket



4242-007	3/4	50	0	070	4.68
4242-010	1	50	0	070	6.03
4242-012	1-1/4	20	0	070	8.20
4242-015	1-1/2	25	0	070	11.25
4242-020	2	20	0	070	13.93
4242-025	2-1/2	5	0	070	19.53
4242-030	3	5	0	070	27.97

Cross

Socket x Socket x Socket x Socket



4220-007	3/4	20	0	070	5.88
4220-010	1	15	0	070	7.35
4220-012	1-1/4	10	0	070	10.24
4220-015	1-1/2	10	0	070	13.98
4220-020	2	8	0	070	22.77
4220-025	2-1/2	5	0	070	50.04
4220-030	3	5	0	070	73.39

Reducing Cross

Socket x Socket x Socket x Socket



4220-131	1X3/4	20	0	070	7.94
----------	-------	----	---	-----	------

FlameGuard® CPVC Fire Sprinkler Products
FlameGuard® CPVC Fire Sprinkler Piping Products



Part Number	Size	Std Pk	Mstr Ctn	Disc Code	Price Each
-------------	------	--------	----------	-----------	------------

Reducing Cross (continued)

Socket x Socket x Socket x Socket

4220-167	1-1/4X3/4	25	0	070	12.26
4220-210	1-1/2X3/4	15	0	070	17.11
4220-289	2-1/2X1	15	0	070	31.65

Coupling

Socket x Socket



4229-007	3/4	25	500	070	2.68
4229-010	1	25	250	070	3.43
4229-012	1-1/4	10	160	070	5.15
4229-015	1-1/2	10	100	070	7.35
4229-020	2	20	0	070	9.91
4229-025	2-1/2	10	0	070	15.09
4229-030	3	5	0	070	19.63

Reducer Coupling

Socket x Socket

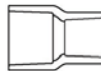

4229-131	1X3/4	15	270	070	3.43
4229-167	1-1/4X3/4	25	0	070	5.33
4229-168	1-1/4X1	10	140	070	5.15
4229-210	1-1/2X3/4	25	0	070	7.94
4229-211	1-1/2X1	10	70	070	7.72
4229-212	1-1/2X1-1/4	10	120	070	7.35
4229-248	2X3/4	10	80	070	10.35
4229-249	2X1	10	60	070	10.35
4229-250	2X1-1/4	10	60	070	10.09
4229-251	2X1-1/2	10	100	070	9.91
4229-291	2-1/2X1-1/2	10	0	070	15.25
4229-292	2-1/2X2	10	0	070	15.63
4229-339	3X2-1/2	5	0	070	46.42

Grooved Coupling Adapter

Groove x Socket

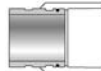

4233-012	1-1/4	10	40	076	103.14
4233-015	1-1/2	10	40	076	109.31
4233-020	2	8	32	076	126.60
4233-025	2-1/2	5	0	076	162.39
4233-030	3	5	0	076	180.53

Not intended to convey or dispense water for human consumption through drinking or cooking

Male Adapter

MIPT x Socket

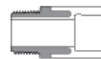

4236-007	3/4	40	160	076	41.02
4236-010	1	10	60	076	62.72
4236-012	1-1/4	10	60	076	75.00
4236-015	1-1/2	10	40	076	136.12
4236-020	2	8	32	076	181.14

Female Adapter - Brass Thread Insert Style

Socket x FIPT

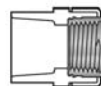

4235-007	3/4	15	90	076	18.23
4235-010	1	15	90	076	31.99
4235-012	1-1/4	15	60	076	52.15
4235-015	1-1/2	10	40	076	69.57
4235-020	2	8	32	076	87.19

Not intended to convey or dispense water for human consumption through drinking or cooking

Part Number	Size	Std Pk	Mstr Ctn	Disc Code	Price Each
-------------	------	--------	----------	-----------	------------

Female Adapter - Special Reinforced Plastic Thread Style

Socket x SR FIPT - Stainless Steel Collar

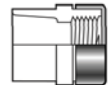

4235-007SR	3/4	25	300	076	8.65
4235-010SR	1	25	200	076	15.21
4235-012SR	1-1/4	10	60	076	24.76

Spigot Female Adapter - Brass Thread Insert Style

Spigot x FIPT

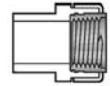

4278-007	3/4	25	150	076	17.05
4278-010	1	15	90	076	30.37

Not intended to convey or dispense water for human consumption through drinking or cooking

Spigot Female Adapter - Special Reinforced Plastic Thread Style

Spigot x SR FIPT - Stainless Steel Collar

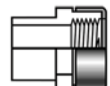

4278-007SR	3/4	25	300	076	9.08
4278-010SR	1	50	0	076	16.17

TorqueSafe™ Female Sprinkler Head Adapter - Gasket Sealed Brass Thread Insert Style

Socket x Gasket FIPT

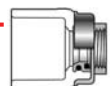

4235-101 G	3/4X1/2	50	0	076	9.96
4235-130GS	1X1/2	50	0	076	10.63
4235-131 G	1X3/4	50	0	076	16.80

FIPT With Elastomer Seal - Use NO Thread Sealant. Not intended to convey or dispense water for human consumption through drinking or cooking

Female Sprinkler Head Adapter - Brass Thread Insert Style

Socket x FIPT

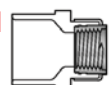

4235-101	3/4X1/2	50	0	076	9.96
4235-130	1X1/2	50	0	076	10.63
4235-131	1X3/4	50	0	076	16.80

Not intended to convey or dispense water for human consumption through drinking or cooking

Female Sprinkler Head Adapter - Special Reinforced Plastic Thread Style

Socket x SR FIPT - Stainless Steel Collar

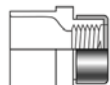

4235-101SR	3/4X1/2	50	200	076	5.28
4235-130SR	1X1/2	50	0	076	5.65
4235-131SR	1X3/4	50	0	076	8.95

Female Sprinkler Head Adapter - Special Reinforced Plastic Thread Style with Socket Body Wrench Flats

Socket x SR FIPT - Stainless Steel Collar

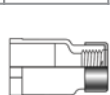

W4235-101SR	3/4X1/2	50	0	076	6.03
W4235-130SR	1X1/2	50	0	076	6.45

Female Sprinkler Head Adapter - Special Reinforced Plastic Thread with Metal Thread Start

Socket x SR FIPT - Zinc Collar

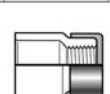

Z4235-101SR	3/4X1/2	50	200	076	5.28
-------------	---------	----	-----	-----	------

Female Sprinkler Head Adapter - Brass Thread Insert Style with Long Body

Socket x FIPT

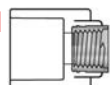

L4235-130	1X1/2	50	0	076	15.07
-----------	-------	----	---	-----	-------

Not intended to convey or dispense water for human consumption through drinking or cooking



FlameGuard® CPVC Fire Sprinkler Products
FlameGuard® CPVC Fire Sprinkler Piping Products

Part Number	Size	Std Pk	Mstr Ctn	Disc Code	Price Each
-------------	------	--------	----------	-----------	------------

Female Sprinkler Head Adapter - Brass Thread Insert Style with Positioning Ring

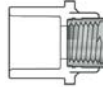

Socket x FIPT

R4235-101	3/4X1/2	50	0	076	9.96
-----------	---------	----	---	-----	------

Not intended to convey or dispense water for human consumption through drinking or cooking

Female Sprinkler Head Adapter - Special Reinforced Plastic Thread Style with Positioning Ring

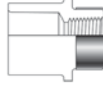

Socket x SR FIPT - Stainless Steel Collar

R4235-101SR	3/4X1/2	25	300	076	5.97
-------------	---------	----	-----	-----	------

TorqueSafe™ Female Spigot Sprinkler Head Adapters - Gasket Sealed Brass Thread Insert Style

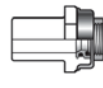

Spigot x Gasket FIPT x Socket With Elastomer Seal - Use NO Thread Sealant

4238-101 G	3/4X1/2	50	200	076	9.96
4238-130 G	1X1/2	50	0	076	10.63

FIPT With Elastomer Seal - Use NO Thread Sealant. Not intended to convey or dispense water for human consumption through drinking or cooking

Spigot Female Sprinkler Head Adapters - Brass Thread Insert Style

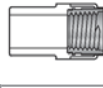

Spigot x FIPT

4238-101	3/4X1/2	50	0	076	9.96
4238-130	1X1/2	50	0	076	10.63

Not intended to convey or dispense water for human consumption through drinking or cooking

TorqueSafe™ Bushing - Gasket Sealed Brass Thread Insert Style

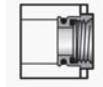

Spigot x Gasket FIPT With Elastomer Seal - Use NO Thread Sealant

4238-130BR G	1X1/2	50	300	076	13.76
--------------	-------	----	-----	-----	-------

FIPT With Elastomer Seal - Use NO Thread Sealant. Not intended to convey or dispense water for human consumption through drinking or cooking

Replacement Gaskets for all TorqueSafe™ Gasket Sealed Head Adapters



Pack of 25 EPDM Gaskets

For Use in 1/2" or 3/4" Gasket Sealed Threads

RGSK-005	1/2	0	0	299	10.62
RGSK-007	3/4	0	0	299	14.84

Bushing - with Brass Thread Insert

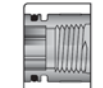

Spigot x FIPT

4238-130BR	1X1/2	50	300	076	13.76
------------	-------	----	-----	-----	-------

Not intended to convey or dispense water for human consumption through drinking or cooking

Spigot Female Sprinkler Head Adapters - Special Reinforced Plastic Threaded Style

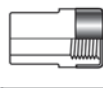

Spigot x SR FIPT - Stainless Steel Collar

4238-101SR	3/4X1/2	50	400	076	5.28
4238-130SR	1X1/2	50	0	076	5.72

Adjustable Sprinkler Head Adapters - Special Reinforced Plastic Thread Style

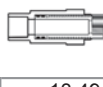

Socket x SR FIPT - Stainless Steel Collar

42001SR	3/4X1/2	12	0	076	13.49
42011SR	1X1/2	12	0	076	13.49

Part Number	Size	Std Pk	Mstr Ctn	Disc Code	Price Each
-------------	------	--------	----------	-----------	------------

Adjustable Sprinkler Head Adapters - Special Reinforced Plastic Thread Style

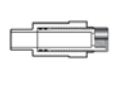

Socket x SR FIPT - Stainless Steel Collar

42004SR	3/4X1/2	12	0	076	13.49
42014SR	1X1/2	12	0	076	13.49

Reducer Bushing - Flush Style



Spigot x Socket

4237-131	1X3/4	50	700	070	2.08
4237-167	1-1/4X3/4	25	200	070	3.27
4237-168	1-1/4X1	25	350	070	3.27
4237-210	1-1/2X3/4	25	125	070	3.68
4237-211	1-1/2X1	25	150	070	3.68
4237-212	1-1/2X1-1/4	25	300	070	3.68
4237-248	2X3/4	10	160	070	5.40
4237-249	2X1	10	160	070	5.40
4237-250	2X1-1/4	10	160	070	5.40
4237-251	2X1-1/2	10	160	070	5.40
4237-290	2-1/2X1-1/4	10	0	070	9.34
4237-291	2-1/2X1-1/2	10	0	070	9.34
4237-292	2-1/2X2	15	0	070	9.34
4237-338	3X2	10	0	070	13.98
4237-339	3X2-1/2	10	0	070	13.98

Cap Socket



4247-007	3/4	25	400	070	1.62
4247-010	1	25	450	070	2.34
4247-012	1-1/4	10	120	070	3.68
4247-015	1-1/2	10	160	070	5.11
4247-020	2	10	60	070	7.78
4247-025	2-1/2	5	40	070	11.04
4247-030	3	5	0	070	18.06

Test Plug - O-ring Sealed

MIPT - For Pressure Testing Only. NOT for use with TorqueSafe™ or Z4235 Series Adapters

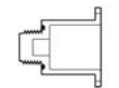

FTP-005	1/2	50	400	079	1.78
---------	-----	----	-----	-----	------

DO NOT use with Tape or Paste thread sealants

Test Plug Replacement O-ring

Buna-N, For O-ring Sealed Test Plug Only



B-116	116	100	0	901	.12
-------	-----	-----	---	-----	-----

For Use With FTP-005 Test Plug

Test Plug for TorqueSafe™ Gasket Sealed Head Adapters

MIPT - For Pressure Testing Only. Use ONLY with Gasket Sealed Head Adapters

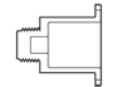

FTP-005GS	1/2	50	400	079	1.78
-----------	-----	----	-----	-----	------

Test Plug - White PVC

MIPT - For Pressure Testing Only

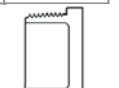

4250-005	1/2	50	400	070	1.76
----------	-----	----	-----	-----	------

Requires use of a thread sealant

Flange

Socket - 4 Bolt Holes - 175 lb.

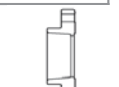

4251-007	3/4	25	0	070	5.79
4251-010	1	15	0	070	7.69

FlameGuard® CPVC Fire Sprinkler Products
FlameGuard® CPVC Fire Sprinkler Piping Products



Part Number	Size	Std Pk	Mstr Ctn	Disc Code	Price Each
-------------	------	--------	----------	-----------	------------

Flange (continued)

Socket - 4 Bolt Holes - 175 lb.

4251-012	1-1/4	15	0	070	9.91
4251-015	1-1/2	15	0	070	11.48
4251-020	2	10	0	070	17.55
4251-025	2-1/2	10	0	070	29.69

Flange - Van Stone Style

Socket - 4 Bolt Holes - 175 lb.

4254-030	3	10	0	070	36.49
----------	---	----	---	-----	-------

Blind Flange

4 Bolt Holes - 175 lb.

4253-007	3/4	25	0	070	5.79
4253-010	1	15	0	070	8.23
4253-012	1-1/4	15	0	070	10.52
4253-015	1-1/2	15	0	070	11.82
4253-020	2	10	0	070	19.35
4253-025	2-1/2	10	0	070	31.11
4253-030	3	10	0	070	34.17

Flange - Van Stone Style

Spigot - 4 Bolt Holes - 175 lb.

4256-007	3/4	25	0	070	5.97
4256-010	1	15	0	070	8.42
4256-012	1-1/4	15	0	070	10.77
4256-015	1-1/2	15	0	070	12.09
4256-020	2	10	0	070	19.72
4256-025	2-1/2	10	0	070	31.54
4256-030	3	10	0	070	36.80

Union

Socket x Socket

175 psi @ 73°F (23°C)

4257-007	3/4	10	80	070	7.46
4257-010	1	10	40	070	13.53
4257-012	1-1/4	5	20	070	17.71
4257-015	1-1/2	5	0	070	20.99
4257-020	2	5	0	070	34.49

Transition Union - Metal Thread Insert Style

Socket x FIPT

175 psi @ 73°F (23°C)

4259-010BR	1	10	0	076	47.01
4259-012BR	1-1/4	5	20	076	68.93
4259-015BR	1-1/2	5	0	076	97.95
4259-020BR	2	5	0	076	144.44

Not intended to convey or dispense water for human consumption through drinking or cooking

Short Repair Couplings

Spigot x Socket

SH118-07CO	3/4	30	0	025	13.56
SH118-10CO	1	35	0	025	21.98

Blue 75™ Thread Sealant

SB75-005	1/4 Pint	24	0	895	10.46
SB75-010	1/2 Pint	24	0	895	16.66

Part Number	Size	Std Pk	Mstr Ctn	Disc Code	Price Each
-------------	------	--------	----------	-----------	------------

Blue 75™ Thread Sealant (continued)

SB75-020	Pint	12	0	895	26.94
SB75-030	Quart	12	0	895	48.41

FS5 One-Step Cement

FS5-020	Pint	12	0	703	28.25
FS5-030	Quart	12	0	703	51.83

Accessories

Empty Can

MT-654*	Pint	12	0	710	7.40
MT-651*	Quart	12	0	710	8.36
MT-653**	Quart	12	0	710	8.36

* 1-3/4" Screw Neck

**TT Paint Type

Brush

KD-110	4-1/2" Length	25	0	710	9.59
KD-112	5-1/2" length	25	0	710	9.59

1" Brush w/1-3/4" Screw Cap, for pipe size 3/4" - 2"

Roller

3020	3" length	20	0	710	16.03
------	-----------	----	---	-----	-------

Fits Paint Type Quart Can (MT-653). For use with pipe sizes 3"

Dauber

DP-75	3/4" for Pint	50	0	710	1.31
DP-125	1-1/4" for Pint	50	0	710	1.58
DQ-125	1-1/4" for Quart	50	0	710	1.58

* 3/4" Diameter fits Pint Cans, for pipe size 3/4"

** 1-1/2" Diameter fits Pint Cans, for pipe size 1-1/2"

***1-1/2" Diameter fits Quart Cans, for pipe size 1-1/2"

Can-Mate Dauber

CM-75	3/4"	50	0	710	5.26
CM-150	1-1/4"	50	0	710	5.26

3/4" Diameter fits Pint or Quart Cans, for pipe sizes 3/4" - 1-1/4"

1-1/4" Diameter fits Pint or Quart Cans, for pipe sizes 1-1/2" - 3"

Deburring Tool

Cone Type for pipe 3/4" - 2"

DEB-2	1/2 to 2 Pipe	1	6	710	97.71
-------	---------------	---	---	-----	-------



Spears® Sprinkler Head Adapter Removal Kit

Occasionally a Sprinkler Head Adapter may need to be removed for relocation, extension or repair. Kit includes Cutter, Deburring Tool and Wrench. Cutter provides easy cutting of pipe from the inside (using a power drill) to remove adapters without disturbing ceiling or side wall. Deburring Tool allows removal of burrs in cut pipe. Wrench is designed to hold Spears® TorqueSafe™ Head Adapter brass insert from rotating to aid in sprinkler head removal from adapter, if required.

Part Number	Size	Std Pk	Mstr Ctn	Disc Code	Price Each
-------------	------	--------	----------	-----------	------------

Complete Kit

Inside Pipe Cutter, Deburring Tool and Wrench



SHRK-005	3/4" & 1" Pipe	24	0	299	537.82
----------	----------------	----	---	-----	--------

Part Number	Size	Std Pk	Mstr Ctn	Disc Code	Price Each
-------------	------	--------	----------	-----------	------------

Deburring Tool Only



GSB-005	3/4" & 1" Pipe	24	0	299	364.63
---------	----------------	----	---	-----	--------

Inside Pipe Cutter Only



GSC-005	3/4" & 1" Pipe	80	0	299	316.05
---------	----------------	----	---	-----	--------

Wrench Only



GSW-005	For 1/2" Outlet	50	0	299	131.16
---------	-----------------	----	---	-----	--------

CPVC Riser Drain Valves For NFPA 13D Installations Only

FlameGuard® CPVC Drain & Check Valves For NFPA 13D Applications Only

Application: FlameGuard® CPVC Orange Check Valves and PVC/CPVC True Union Drain Valves are for use in configuring CPVC Fire Sprinkler System connection to water supply (riser/drain assembly) in NFPA 13D installations only. These valves are not UL Listed and NOT for use in any other locations within the fire sprinkler system.

Part Number	Size	Std Pk	Mstr Ctn	Disc Code	Price Each
-------------	------	--------	----------	-----------	------------

True Union Industrial Drain Valve With Locking Handle

Socket x Socket



CPVC Gray Valve with, CPVC Orange End Connector

1822-007CFG	3/4	1	18	004	82.65
1822-010CFG	1	1	12	004	98.40
1822-012CFG	1-1/4	1	8	004	156.43
1822-015CFG	1-1/2	1	8	004	165.21
1822-020CFG	2	1	4	004	220.95

Not UL Listed

True Union Standard Drain Valves PVC Valve with CPVC End Connector

Socket x Socket



PVC Valve with CPVC End Connector

3622-007FG	3/4	1	18	004	47.03
3622-010FG	1	1	12	004	56.02

Not UL Listed

CPVC Check Valves

Socket x Socket



S1520-10CO	1	20	0	004	32.12
S1520-12CO	1-1/4	12	0	004	35.89
S1520-15CO	1-1/2	12	0	004	40.36

Not UL Listed

CPVC Special Reinforced Thread Inlet Check Valves

SR Fipt x Socket



S1520-10FSRSCO	1	20	0	004	34.78
----------------	---	----	---	-----	-------

Part Number	Size	Std Pk	Mstr Ctn	Disc Code	Price Each
-------------	------	--------	----------	-----------	------------

CPVC Special Reinforced Thread Inlet Check Valves

(continued)

SR Fipt x Socket

S1520-12FSRSCO	1-1/4	12	0	004	40.16
S1520-15FSRSCO	1-1/2	12	0	004	47.64

Not UL Listed

General Installation Information: Socket end connections should be installed using Spears® FS-5 One-Step Cement for use with Spears® CPVC Fire Sprinkler Products. Threaded connections should be made using Spears® **BLUE 75™** Thread Sealant tested for compatibility with CPVC materials. PVC True Union Drain Valves are to be installed with system connection to Valve CPVC End Connector. Swing check valves are designed for horizontal installations, but may be installed in up-flow only vertical position. Check valves **MUST** be installed with the valve's FLOW arrow pointing in the direction of the flow. Do not install valve upside down.

**FlameGuard® CPVC Fire Sprinkler Products
CPVC Riser Drain Valves For NFPA 13D Installations Only**



FlameGuard® CPVC Drain & Check Valves For NFPA 13D Applications Only

Specifications

True Union Industrial Drain Valve:

Nominal Size Range	3/4", 1", 1-1/4", 1-1/2", 2"
Type	1/4-Turn Ball Valve, True Union Style with Locking Handle
Material	CPVC Gray w/CPVC Orange End Connector
Seats	PTFE
Seals	EPDM
Handle	Polypropylene, Red
End Connections	Socket x Socket

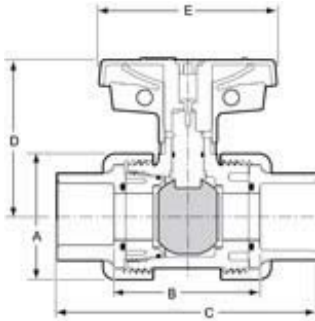

Socket x Socket Part Number	Nominal Size	Dimension Reference (inches, ± 1/16)				
		A	B	C	D	E
1822-007CFG	3/4	2-1/4	2-3/4	4-3/4	2-7/8	3-3/8
1822-010CFG	1	2-1/2	2-7/8	5-1/8	3-1/8	3-7/16
1822-012CFG	1-1/4	3-1/16	3-1/4	5-3/4	3-5/8	3-7/8
1822-015CFG	1-1/2	3-1/2	3-1/2	6-1/4	4	4-3/16
1822-020CFG	2	4-1/4	4-3/4	7-3/4	4-1/2	5-1/8

True Union Standard Drain Valve:

Nominal Size Range	3/4", 1"
Type	1/4-Turn Ball Valve, True Union Style
Material	PVC w/CPVC Orange End Connector
Seats	PTFE/HDPE
Seals	EPDM
Handle	Polypropylene, Red
End Connections	Socket x Socket

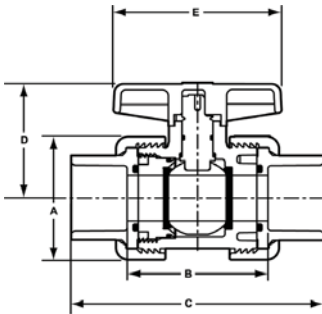

Socket x Socket Part Number	Nominal Size	Dimension Reference (inches, ± 1/16)				
		A	B	C	D	E
3622-007FG	3/4	2-1/4	2-3/4	4-3/4	2	3
3622-010FG	1	2-1/2	2-7/8	5-1/8	2-5/16	3-7/16

Check Valve:

Nominal Size Range	1", 1-1/4", 1-1/2"
Type	Swing Check, Maintenance-free Sealed Unit
Material	CPVC, Orange
Seat	EPDM
End Connections	Socket x Socket Special Reinforced (SR) Female Plastic Thread Inlet x Socket

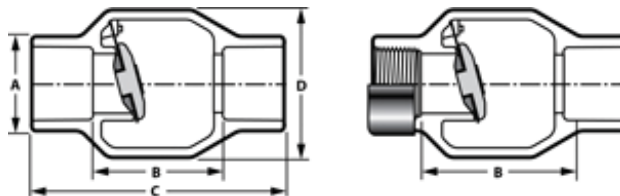

Socket x Socket Part Number	SR Thread x Socket Part Number	Nominal Size	Dimension Reference (inches, ± 1/16)					C _v (GPM)
			A	B		C	D	
				Socket	SR Thread			
S1520-10CO	S1520-10FSRSCO	1	1-11/16	2-5/16	2-15/16	4-9/16	2-5/8	33
S1520-12CO	S1520-12FSRSCO	1-1/4	2-1/16	2-15/16	3-5/8	5-1/2	3-3/8	42
S1520-15CO	S1520-15FSRSCO	1-1/2	2-7/16	3	3-11/16	5-5/8	3-3/8	89